

RAS-07CH4/RAC-07CH4 RAS-09CH4/RAC-09CH4

SERVICE MANUAL

TECHNICAL INFORMATION

FOR SERVICE PERSONNEL ONLY

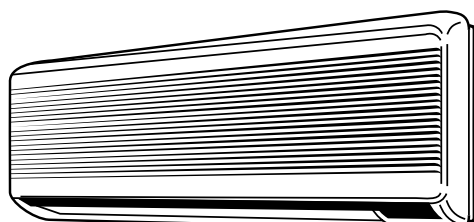

RAS-07CH4
RAS-09CH4

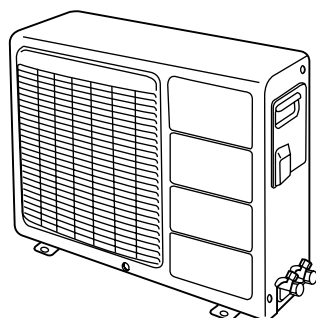

RAC-07CH4
RAC-09CH4

REFER TO THE FOUNDATION MANUAL

CONTENTS

SPECIFICATIONS	5
HOW TO USE	6
CONSTRUCTION AND DIMENSIONAL DIAGRAM	32
MAIN PARTS COMPONENTS	33
WIRING DIAGRAM	35
BASIC MODE	41
REFRIGERATING CYCLE	46
AUTO SWING FUNCTION	47
SERVICE CALL Q & A	48
PARTS LIST AND DIAGRAM	53

SPECIFICATIONS

TYPE		WALL TYPE			
		INDOOR UNIT	OUTDOOR UNIT	INDOOR UNIT	OUTDOOR UNIT
MODEL		RAS-07CH4	RAC-07CH4	RAS-09CH4	RAC-09CH4
POWER SOURCE		1Ø, 220 V, 50 Hz			
COOLING	TOTAL INPUT (W)	680		870	
	TOTAL AMPERES (A)	3.15		4.1	
	CAPACITY (kW)	2.05		2.50	
	(B.T.U./h)	7,000		8,500	
HEATING	TOTAL INPUT (W)	630		860	
	TOTAL AMPERES (A)	3.0		4.1	
	CAPACITY (kW)	2.15		2.65	
	(B.T.U./h)	7,850		10,000	
DIMENSIONS (mm)	W	785	700	785	700
	H	265	570	265	570
	D	168	210	168	210
NET WEIGHT (kg)		7	26	7	26

SPECIFICATIONS AND PARTS ARE SUBJECT TO CHANGE FOR IMPROVEMENT

ROOM AIR CONDITIONER

INDOOR UNIT + OUTDOOR UNIT

SAFETY DURING REPAIR WORK

1. In order to disassemble and repair the unit in question, be sure to disconnect the power cord plug from the power outlet before starting the work.

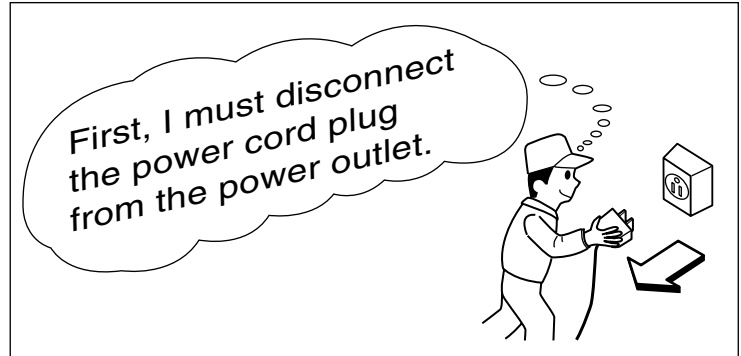

2. If it is necessary to replace any parts, they should be replaced with respective genuine parts for the unit, and the replacement must be effected in correct manner according to the instructions in the Service Manual of the unit.

If the contacts of electrical parts are defective, replace the electrical parts without trying to repair them.

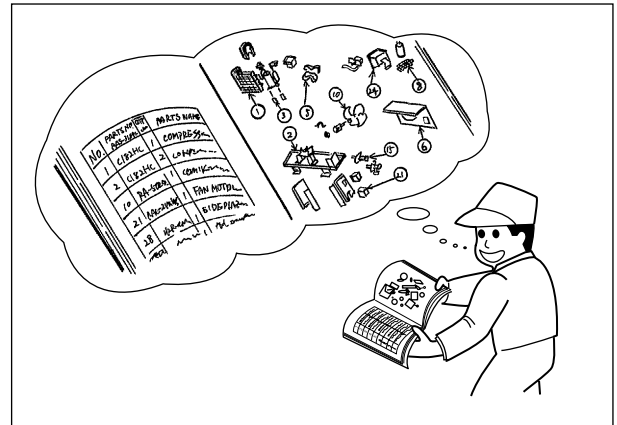

3. After completion of repairs, the initial state should be restored.
4. Lead wires should be connected and laid as in the initial state.
5. Modification of the unit by the user himself should absolutely be prohibited.
6. Tools and measuring instruments for use in repairs or inspection should be accurately calibrated in advance.
7. In installing the unit having been repaired, be careful to prevent the occurrence of any accident such as electrical shock, leak of current, or bodily injury due to the drop of any part.
8. To check the insulation of the unit, measure the insulation resistance between the power cord plug and grounding terminal of the unit. The insulation resistance should be $1M\Omega$ or more as measured by a 500V DC megger.
9. The initial location of installation such as window, floor or the other should be checked for being safe enough to support the repaired unit again. If it is found not so strong and safe, the unit should be installed at the initial location after reinforced or at a new location.
10. Any inflammable object must not be placed about the location of installation.
11. Check the grounding to see whether it is proper or not, and if it is found improper, connect the grounding terminal to the earth.

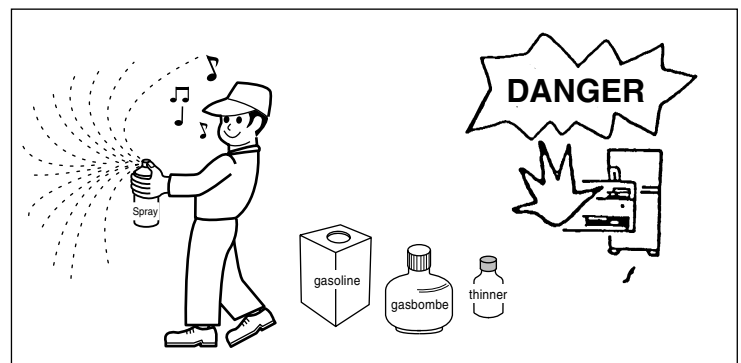

WORKING STANDARDS FOR PREVENTING BREAKAGE OF SEMICONDUCTORS

1. Scope

The standards provide for items to be generally observed in carrying and handling semiconductors in relative manufacturers during maintenance and handling thereof. (They apply the same to handling of abnormal goods such as rejected goods being returned).

2. Object parts

- (1) Micro computer
- (2) Integrated circuits (IC)
- (3) Field-effect transistors (FET)
- (4) P.C. boards or the like on which the parts mentioned in (1) and (2) of this paragraph are equipped.

3. Items to be observed in handling

- (1) Use a conductive container for carrying and storing of parts. (Even rejected goods should be handled in the same way).

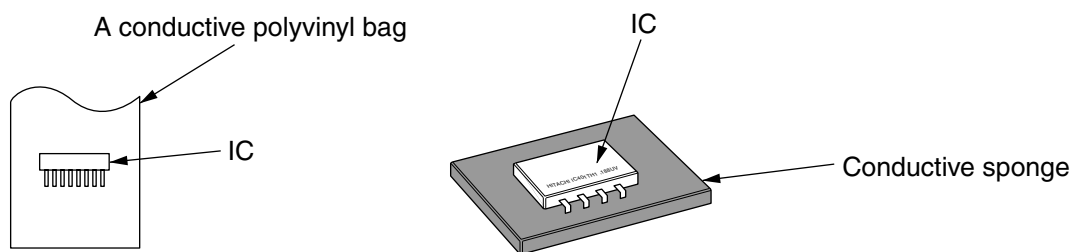

Fig. 1 Conductive Container

- (2) When any part is handled uncovered (in counting, packing and the like), the handling person must always use himself as a body earth. (Make yourself a body earth by passing one M ohm earth resistance through a ring or bracelet).
- (3) Be careful not to touch the parts with your clothing when you hold a part even if a body earth is being taken.
- (4) Be sure to place a part on a metal plate with grounding.
- (5) Be careful not to fail to turn off power when you repair the printed circuit board. At the same time, try to repair the printed circuit board on a grounded metal plate.

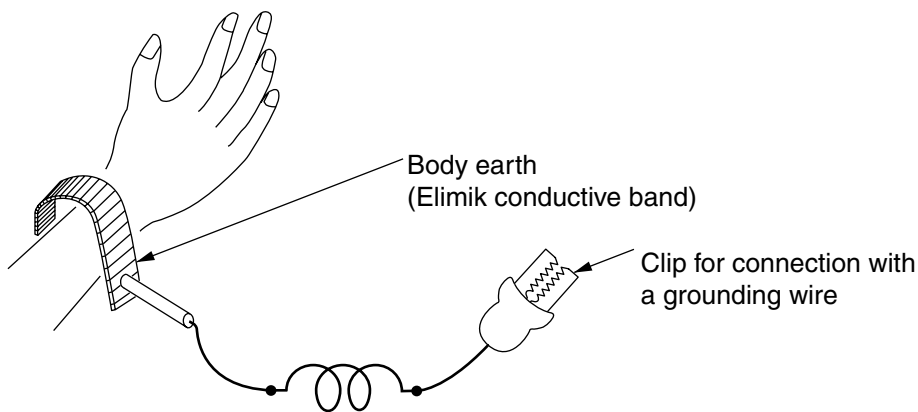

Fig. 2 Body Earth

(6) Use a three wire type soldering iron including a grounding wire.

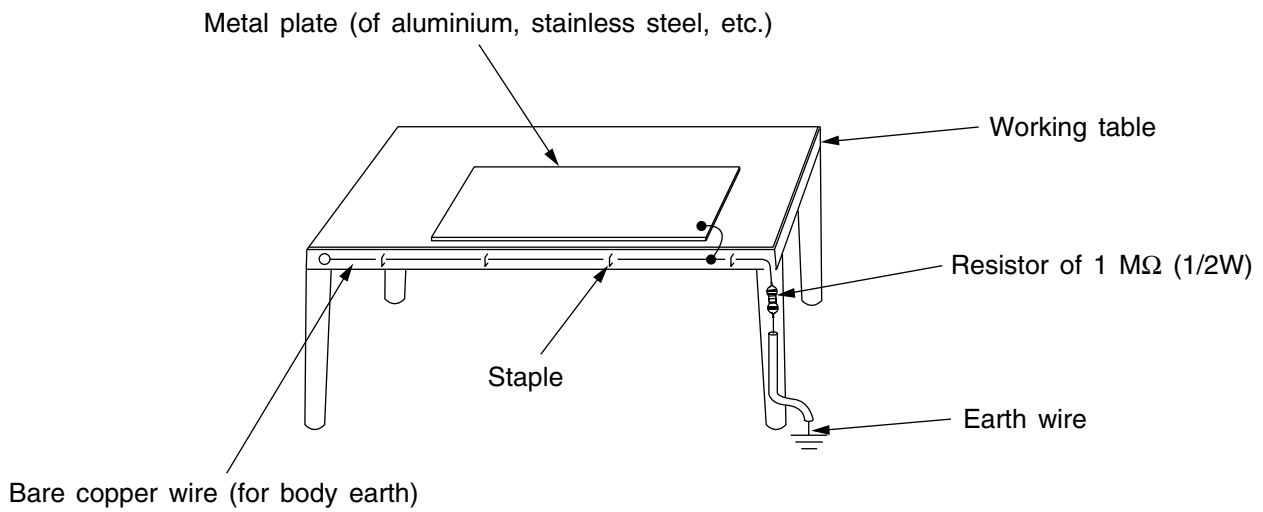

Fig. 3. Grounding of the working table

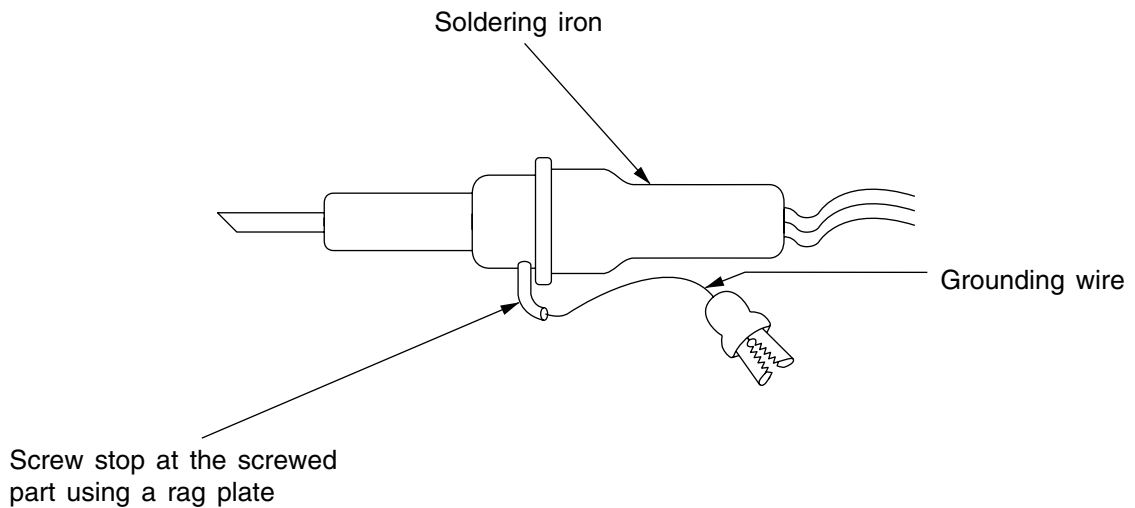

Fig. 4. Grounding a soldering iron

Use a high insulation mode (100V, 10MΩ or higher) when ordinary iron is to be used.

(7) In checking circuits for maintenance, inspection or some others, be careful not to have the test probes of the measuring instrument shortcircuit a load circuit or the like.

 **CAUTION**

1. In quiet or stop operation, slight flowing noise of refrigerant in the refrigerating cycle is heard occasionally, but this noise is not abnormal for the operation.
2. When it thunders near by, it is recommend to stop the operation and to disconnect the power cord plug from the power outlet for safety.
3. If the room air conditioner is stopped by setting the temperature or mis-operation, and then re-started in a moment, cooling operation does not start for 3 minutes, it is not abnormal and this is the result of the operation of IC delay circuit. This IC delay circuit ensures that there is no danger of blowing fuse or damaging parts even if operation is restarted accidentally.
4. This room air conditioner should not be used at the cooling operation when the outside temperature is below 20°C.
5. When the operation knob is set to "COOL" from another position, IC delay circuit functions and stops the compressor for the first 3 minutes, which is not an abnormal phenomenon.

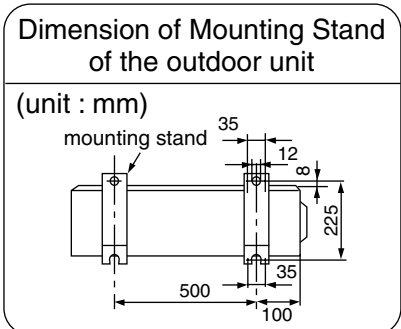
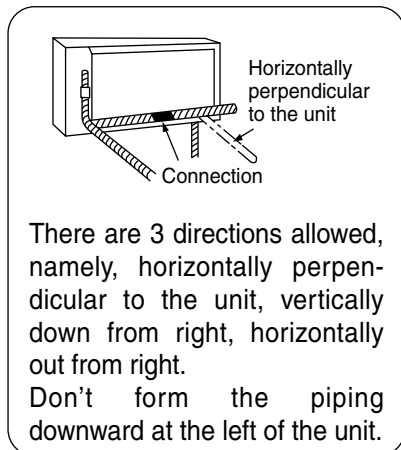
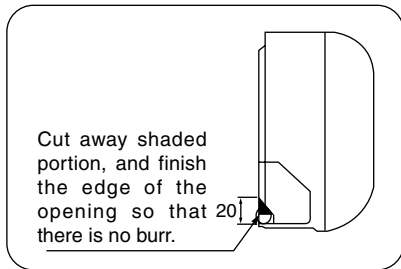
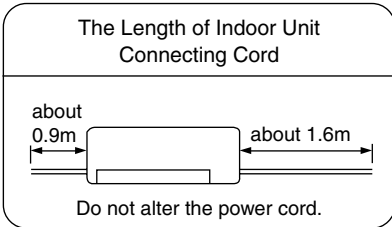
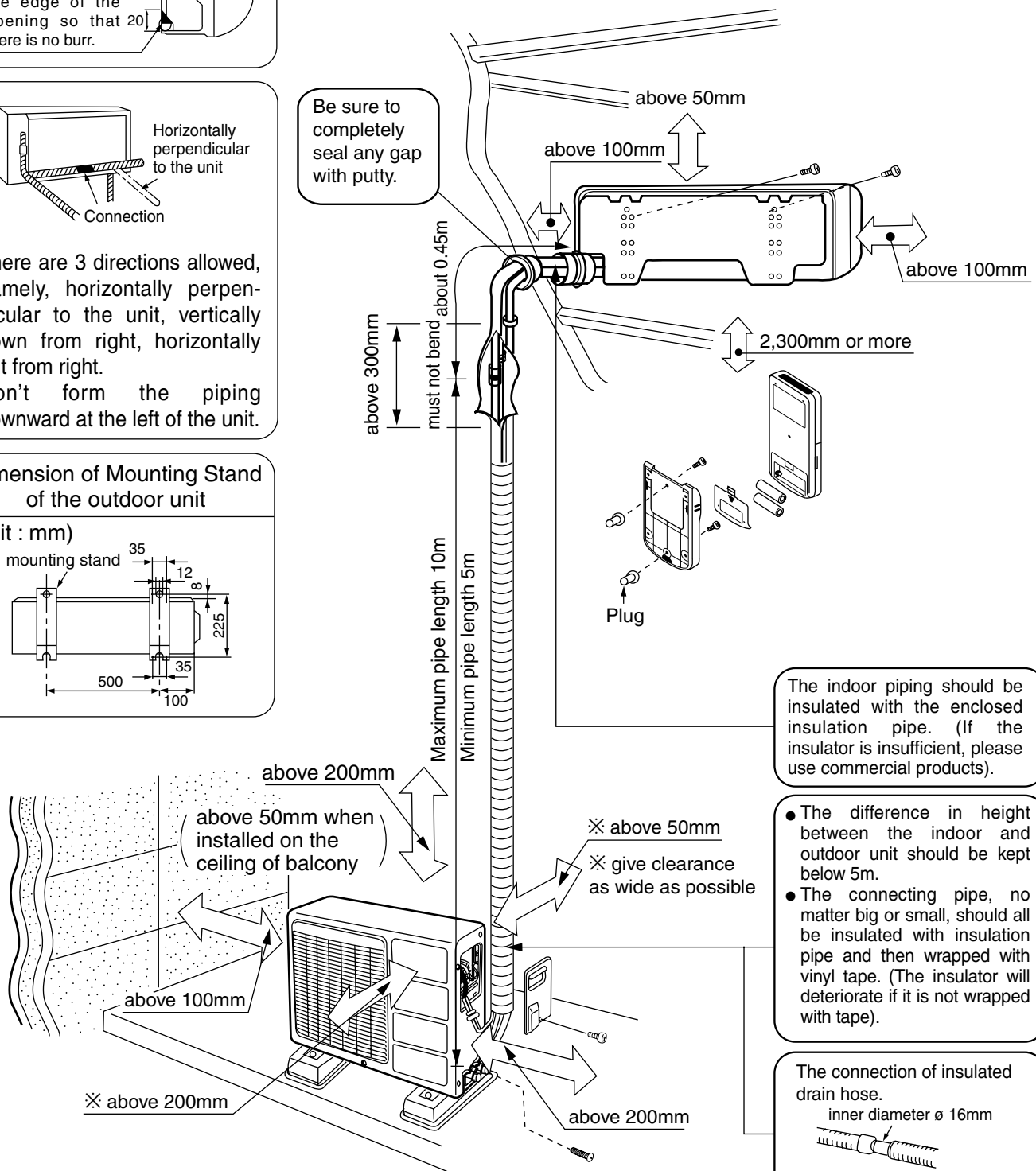

Figure showing the Installation of Indoor and Outdoor unit.



Be sure to completely seal any gap with putty.

The indoor piping should be insulated with the enclosed insulation pipe. (If the insulator is insufficient, please use commercial products).

- The difference in height between the indoor and outdoor unit should be kept below 5m.
- The connecting pipe, no matter big or small, should all be insulated with insulation pipe and then wrapped with vinyl tape. (The insulator will deteriorate if it is not wrapped with tape).

The connection of insulated drain hose.
inner diameter ϕ 16mm

Please use insulated drain hose for the indoor piping (commercial product.)

SPECIFICATIONS

MODEL	RAS-07CH4	RAC-07CH4	RAS-09CH4	RAC-09CH4	
FAN MOTOR	10 W	20 W	10 W	20 W	
FAN MOTOR CAPACITOR	1 μ F, 400 V	1.5 μ F, 400 V	1 μ F, 400 V	1.5 μ F, 400 V	
FAN MOTOR PROTECTOR	YES (INTERNAL)	YES (INTERNAL)	YES (INTERNAL)	YES (INTERNAL)	
COMPRESSOR	NO	G333DB2Z	NO	G533QB9Z	
COMPRESSOR MOTOR CAPACITOR	NO	30 μ F, 400 V	NO	30 μ F, 400 V	
OVERLOAD PROTECTOR	NO	YES	NO	YES	
OVERHEAT PROTECTOR	NO	NO	NO	NO	
FUSE (for MICRO COMPUTER)	3.0 A	NO			
POWER RELAY	G4A	NO	G4A	NO	
POWER SWITCH	YES	NO	YES	NO	
TEMPORARY SWITCH	YES	NO	YES	NO	
SERVICE SWITCH	YES	NO	YES	NO	
TRANSFORMER	YES	NO	YES	NO	
VARISTOR	450NR	NO	450NR	NO	
NOISE SUPPRESSOR	NO	NO	NO	NO	
REMOTE CONTROL SWITCH (LIQUID CRYSTAL)	YES	NO	YES	NO	
THERMOSTAT	YES (IC)	NO	YES (IC)	NO	
FUSE CAPACITY	10 A TIME DELAY FUSE				
REFRIGERANT CHARGING VOLUME (Refrigerant 22)	UNIT	-----	* 630 g	-----	* 700 g
	PIPES	WITHOUT REFRIGERANT BECAUSE COUPLING IS FLARE TYPE. P - 105 VK1 (5m), P - 108 VK1 (8m)			



* 630g for piping set of 5 ~ 8m.

* 700g for piping set of 5 ~ 8m.







SAFETY PRECAUTION

- Please read the “Safety Precaution” carefully before operating the unit to ensure correct usage of the unit.
- Pay special attention to signs of “**▲ Warning**” and “**▲ Caution**”. The “Warning” section contains matters which, if not observed strictly, may cause death or serious injury. The “Caution” section contains matters which may result in serious consequences if not observed properly. Please observe all instructions strictly to ensure safety.
- The sign indicate the following meanings.



 Make sure to connect earth line.	 The sign in the figure indicates prohibition.
 Indicates the instructions that must be followed.	

- Please keep this manual after reading.





PRECAUTIONS DURING INSTALLATION

 WARNING	<ul style="list-style-type: none"> ● Do not reconstruct the unit. Water leakage, fault, short circuit or fire may occur if you reconstruct the unit by yourself. 	
	<ul style="list-style-type: none"> ● Please ask your sales agent or qualified technician for the installation of your unit. Water leakage, short circuit or fire may occur if you install the unit by yourself. ● Please use earth line. Do not place the earth line near water or gas pipes, lightning-conductor, or the earth line of telephone. Improper installation of earth line may cause electric shock. 	
 CAUTION	<ul style="list-style-type: none"> ● A circuit breaker should be installed depending on the mounting site of the unit. Without a circuit breaker, the danger of electric shock exists. ● Do not install near location where there is flammable gas. The outdoor unit may catch fire if flammable gas leaks around it. ● Please ensure smooth flow of water when installing the drain hose. 	

PRECAUTIONS DURING SHIFTING OR MAINTENANCE

 W A R N I N G	<ul style="list-style-type: none"> ● Should abnormal situation arises (like burning smell), please stop operating the unit and turn off the circuit breaker. Contact your agent. Fault, short circuit or fire may occur if you continue to operate the unit under abnormal situation. 	
	<ul style="list-style-type: none"> ● Please contact your agent for maintenance. Improper self maintenance may cause electric shock and fire. 	
	<ul style="list-style-type: none"> ● Please contact your agent if you need to remove and reinstall the unit. Electric shock or fire may occur if you remove and reinstall the unit yourself improperly. 	

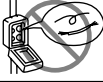
PRECAUTIONS DURING OPERATION

 W A R N I N G	<ul style="list-style-type: none"> ● Avoid an extended period of direct air flow for your health. 	
	<ul style="list-style-type: none"> ● Do not insert a finger, a rod or other objects into the air outlet or inlet. As the fan is rotating at a high speed, it will cause injury. Before cleaning, be sure to stop the operation and turn the breaker OFF. 	
	<ul style="list-style-type: none"> ● Do not use any conductor as fuse wire, this could cause fatal accident. 	
	<ul style="list-style-type: none"> ● During thunder storm, disconnect and turn off the circuit breaker. 	

PRECAUTIONS DURING OPERATION

- The product shall be operated under the manufacturer specification and not for any other intended use.

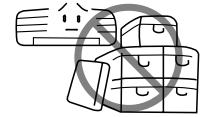

- Do not attempt to operate the unit with wet hands, this could cause fatal accident.

- When operating the unit with burning equipments, regularly ventilate the room to avoid oxygen insufficiency.

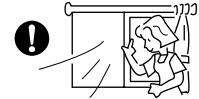

- Do not direct the cool air coming out from the air-conditioner panel to face household heating apparatus as this may affect the working of apparatus such as the electric kettle, oven etc.

- Please ensure that outdoor mounting frame is always stable, firm and without defect. If not, the outdoor unit may collapse and cause danger.



- Do not splash or direct water to the body of the unit when cleaning it as this may cause short circuit.

CAUTION

- Do not use any aerosol or hair sprays near the indoor unit. This chemical can adhere on heat exchanger fin and blocked the evaporation water flow to drain pan. The water will drop on tangential fan and cause water splashing out from indoor unit.

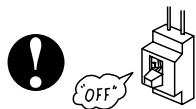

- Please switch off the unit and turn off the circuit breaker during cleaning, the high-speed fan inside the unit may cause danger.

- Turn off the circuit breaker if the unit is not to be operated for a long period.

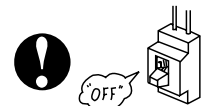

- Do not climb on the outdoor unit or put objects on it.

- Do not put water container (like vase) on the indoor unit to avoid water dripping into the unit. Dripping water will damage the insulator inside the unit and causes short-circuit.

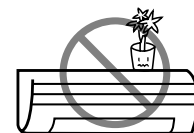

- Do not place plants directly under the air flow as it is bad for the plants.

- When operating the unit with the door and windows opened, (the room humidity is always above 80%) and with the air deflector facing down or moving automatically for a long period of time, water will condense on the air deflector and drips down occasionally. This will wet your furniture. Therefore, do not operate under such condition for a long time.
- If the amount of heat in the room is above the cooling or heating capability of the unit (for example: more people entering the room, using heating equipments and etc.), the preset room temperature cannot be achieved.

NAMES AND FUNCTIONS OF EACH PART

INDOOR UNIT

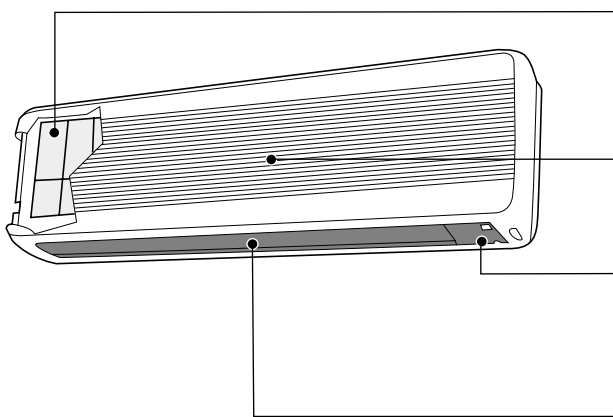

Air Filter

To prevent dust from coming into the indoor unit.
 (Refer page 24)

Suction Grille (Air Inlet)

Indoor unit Indicators

Light indicator showing the operation condition.
 (Refer page 9)

Horizontal Deflector • Vertical Deflector (Air outlet)

(Refer page 20)

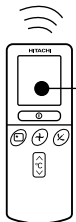

Remote Control

Send out operation signal to the indoor unit.
 So as to operate the whole unit.
 (Refer page 10)

OUTDOOR UNIT

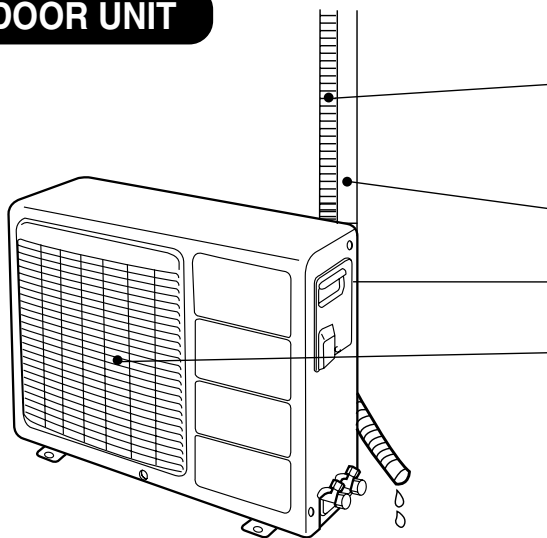

Drain pipe

Condensed water drain to outside.

Connecting cord

Air inlet (Back and left side)

Air outlet

Blow out warm air.

MODEL NAME AND DIMENSIONS

MODEL	WIDTH (mm)	HEIGHT (mm)	DEPTH (mm)
RAS-07CH4, RAS-09CH4	785	265	168
RAC-07CH4, RAC-09CH4	700	570	210

OPERATION INDICATOR

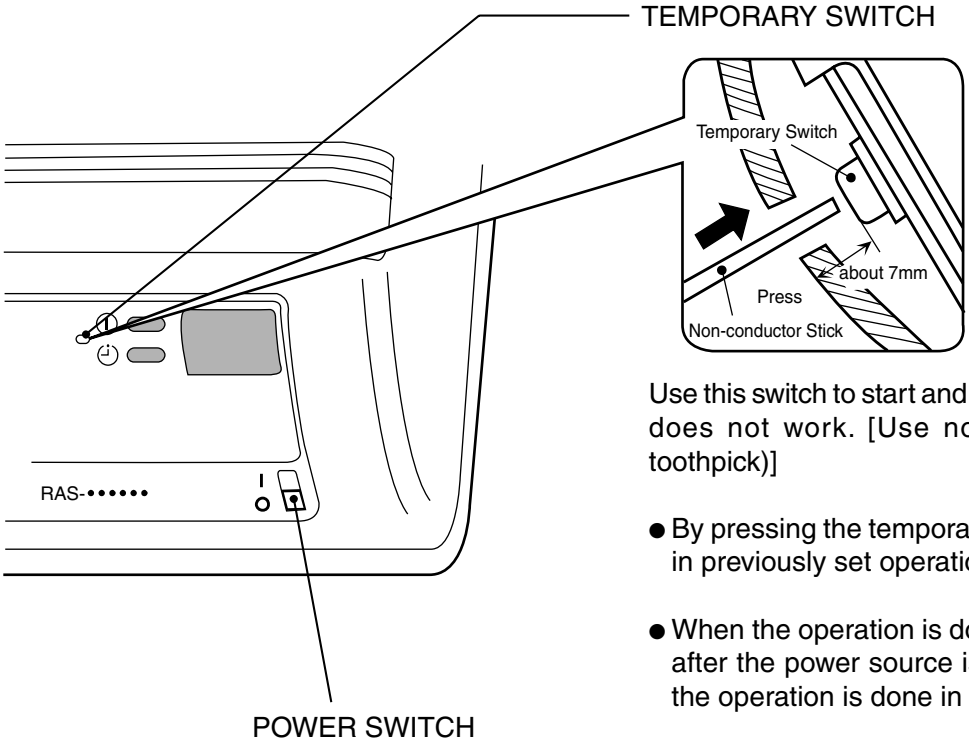

Use this switch to start and stop when the remote controller does not work. [Use non-conductor stick (example toothpick)]

- By pressing the temporary switch, the operation is done in previously set operation mode.
- When the operation is done using the temporary switch after the power source is turned off and turn on again, the operation is done in automatic mode.

INDOOR UNIT INDICATORS

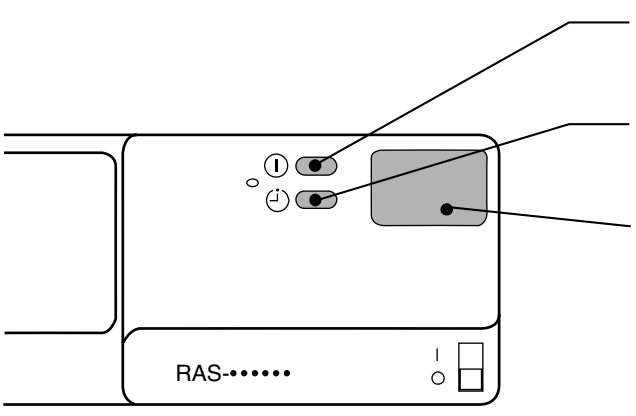

OPERATION LAMP
 This lamp lights during operation.

TIMER LAMP
 This lamp lights when the timer is working.

SIGNAL RECEIVER
 There will be a beep sound when this receiver receives signal from remote control.

NAMES AND FUNCTIONS OF REMOTE CONTROL UNIT

REMOTE CONTROLLER

This controls the operation of the indoor unit. The range of control is about 7 meters. If indoor lighting is controlled electronically, the range of control may be shorter.

This unit can be fixed on a wall using the fixture provided. Before fixing it, make sure the indoor unit can be controlled from the remote controller.

- **Signal emitting window/transmission sign**
Point this window toward the indoor unit when controlling it. The transmission sign blinks when a signal is sent.
- **Display**
This indicates the room temperature selected, current time, timer status, function and intensity of circulation selected.
- **START/STOP button**
Press this button to start operation. Press it again to stop operation.
- **SLEEP button**
Use this button to set the sleep timer.
- **TEMPERATURE button**
Use this button to raise or lower the temperature setting. (Keep pressed, and the value will change more quickly.)
- **TIME button**
Use this button to set and check the time and date.
- **RESET button**
- **FUNCTION selector**
Use this button to select the operating mode. Every time you press it, the mode will change from ☺ (AUTO) to ☀ (HEAT) to ☾ (DEHUMIDIFY) to ❄ (COOL) and to ↻ (FAN) cyclically.
- **FAN SPEED selector**
This determines the fan speed. Every time you press this button, the intensity of circulation will change from ☺ (AUTO) to 🌀 (HI) to 🌀 (MED) to 🌀 (LOW) (during the ↻ (FAN) mode, from 🌀 (HI) to 🌀 (MED) to 🌀 (LOW)).
- **AUTO SWING button**
Controls the angle of the horizontal air deflector.
- **TIMER control**
Use this button to set the timer.
- **OFF-TIMER button** Select the turn OFF time.
- **ON-TIMER button** Select the turn ON time.
- **RESERVE button** Time setting reservation.
- **CANCEL button** Cancel time reservation.

☺	AUTO
☀	HEAT
☾	DEHUMIDIFY
❄	COOL
↻	FAN
🌀	FAN SPEED LOW MED HI
★	SLEEPING
○	STOP (CANCEL)
I	START (RESERVE)
⌚	START/STOP
⌚	TIME
⌚	TIMER SET
⌚	TIMER SELECTOR ON TIMER OFF TIMER
↻	AUTO SWING

Precautions for Use

- Do not put the remote controller in the following places.
 - Under direct sunlight.
 - In the vicinity of a heater.
- Handle the remote controller carefully. Do not drop it on the floor, and protect it from water.
- Once the outdoor unit stops, it will not restart for about 3 minutes (unless you turn the power switch off and on or unplug the power cord and plug it in again).
This is to protect the device and does not indicate a failure.
- If you press the FUNCTION selector button during operation, the device may stop for about 3 minutes for protection.

AUTOMATIC OPERATION

The device will automatically determine the mode of operation, HEAT, COOL or DEHUMIDIFY depending on the initial room temperature. The selected mode of operation will not change when the room temperature varies.

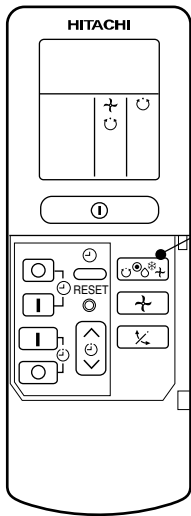

Press the FUNCTION selector so that the display indicates the  (AUTO) mode of operation.

- When AUTO has been selected, the device will automatically determine the mode of operation, HEAT, COOL or DEHUMIDIFY depending on the current room temperature.

**START
STOP**

Press the  (START/STOP) button.

Operation starts with a beep.

Press the button again to stop operation.

- As the settings are stored in memory in the remote controller, you only have to press the  (START/STOP) button next time.

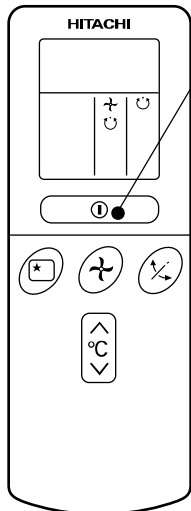

You can raise or lower the temperature setting as necessary by maximum of 3°C.

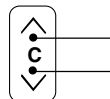

Press the temperature button and the temperature setting will change by 1°C each time.

- The preset temperature and the actual room temperature may vary somewhat depending on conditions.
- The display does not indicate the preset temperature in the AUTO mode. If you change the setting, the indoor unit will produce a beep.

■ CONDITION OF AUTOMATIC OPERATION

- The selected mode of operation will not change during the operation even though the room temperature change.

Initial room temperature (approx.)	Function	Temperature setting	FAN SPEED
Over 27°C	→ COOL	27°C	HI at start, MED or LOW after the preset temperature is reached
23~27°C	→ DEHUMIDIFY	Slightly lower than the room temperature	LOW
Under 23°C	→ HEAT	23°C	HI at start, MED or LOW after the preset temperature is reached

HEATING OPERATION

Use the device for heating when the outdoor temperature is under 21°C.
 When it is too warm (over 21°C), the heating function may not work in order to protect the device.

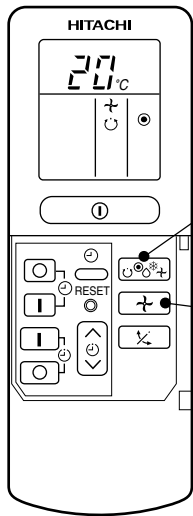





1

Press the FUNCTION selector so that the display indicates the ● (HEAT).

Set the desired fan speed with the ↻ (FAN SPEED) button (the display indicates the setting).

2

-  (AUTO) : The FAN SPEED is HI at first and varies to MED automatically when the preset temperature has been reached.
-  (HI) : Economical as the room will become warm quickly. But you may feel a chill at the beginning.
-  (MED) : Quiet.
-  (LOW) : More quiet.

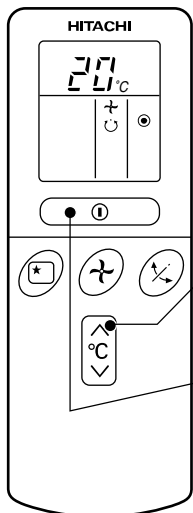

3

Set the desired room temperature with the TEMPERATURE button (the display indicates the setting).



The range of 18-22°C is recommended as the room temperature for heating.
 If the temperature setting is 20°C, the room temperature will be controlled at around 20°C.

The temperature setting and the actual room temperature may vary somewhat depending on conditions.

**START
STOP**

Press the ⏻ (START/STOP) button. Heating operation starts with a beep. Press the button again to stop operation.

- As the settings are stored in memory in the remote controller, you only have to press the ⏻ (START/STOP) button next time.

DEHUMIDIFYING OPERATION

Use the device for dehumidifying when the room temperature is over 16°C.
 When it is under 15°C, the dehumidifying function will not work.

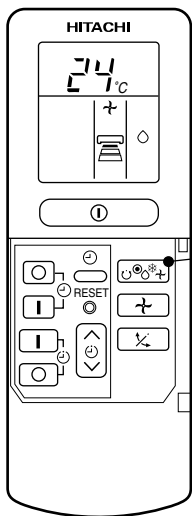

1

Press the FUNCTION selector so that the display indicates ○ (DEHUMIDIFY).
 The FAN SPEED is set at LOW automatically.
 The FAN SPEED button does not work.

2

Set the desired room temperature with the TEMPERATURE button (the display indicates the setting).

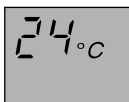

The range of 20-26°C is recommended as the room temperature for dehumidifying.

**START
STOP**

Press the Ⓛ (START/STOP) button. Dehumidifying operation starts with a beep. Press the button again to stop operation.

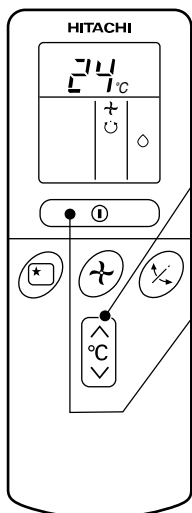

■ As the settings are stored in memory in the remote controller, you only have to press the Ⓛ (START/STOP) button next time.

■ Dehumidifying Function

When the room temperature is higher than the temperature setting: The device will dehumidify the room, reducing the room temperature to the preset level.

When the room temperature is lower than the temperature setting: Dehumidifying will be performed at the temperature setting slightly lower than the current room temperature, regardless of the temperature setting. The function will stop (the indoor unit will stop emitting air) as soon as the room temperature becomes lower than the setting temperature.

COOLING OPERATION

Use the device for cooling when the outdoor temperature is 22-42°C.
If humidity is very high (over 80%) indoors, some dew may form on the air outlet grille of the indoor unit.

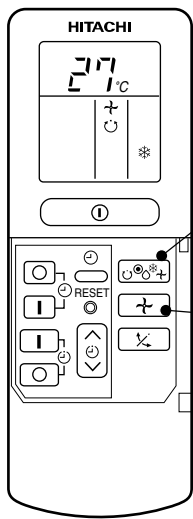

1

Press the FUNCTION selector so that the display indicates the * (COOL).

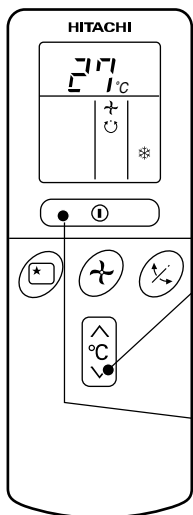

2

Set the desired fan speed with the ↻ (FAN SPEED) button (the display indicates the setting).

- ↻ (AUTO) : The FAN SPEED is HI at first and varies to MED automatically when the preset temperature has been reached.
- ↓ (HI) : Economical as the room will become warm quickly. But you may feel a chill at the beginning.
- ↻ (MED) : Quiet.
- ↻ (LOW) : More quiet.

3

Set the desired room temperature with the TEMPERATURE button (the display indicates the setting).

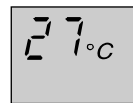

The range of 25-28°C is recommended as the room temperature for cooling.
If the temperature setting is 27°C, the room temperature will be controlled at around 27°C.

The temperature setting and the actual room temperature may vary somewhat depending on conditions.

**START
STOP**

Press the ⏻ (START/STOP) button. Cooling operation starts with a beep. Press the button again to stop operation. The cooling function does not start if the temperature setting is higher than the current room temperature (even though the ⏻ (OPERATION) lamp lights). The cooling function will start as soon as you set the temperature below the current room temperature.

- As the settings are stored in memory in the remote controller, you only have to press the ⏻ (START/STOP) button next time.

FAN OPERATION

You can use the device simply as an air circulator. Use this function to dry the interior of the indoor unit at the end of summer.

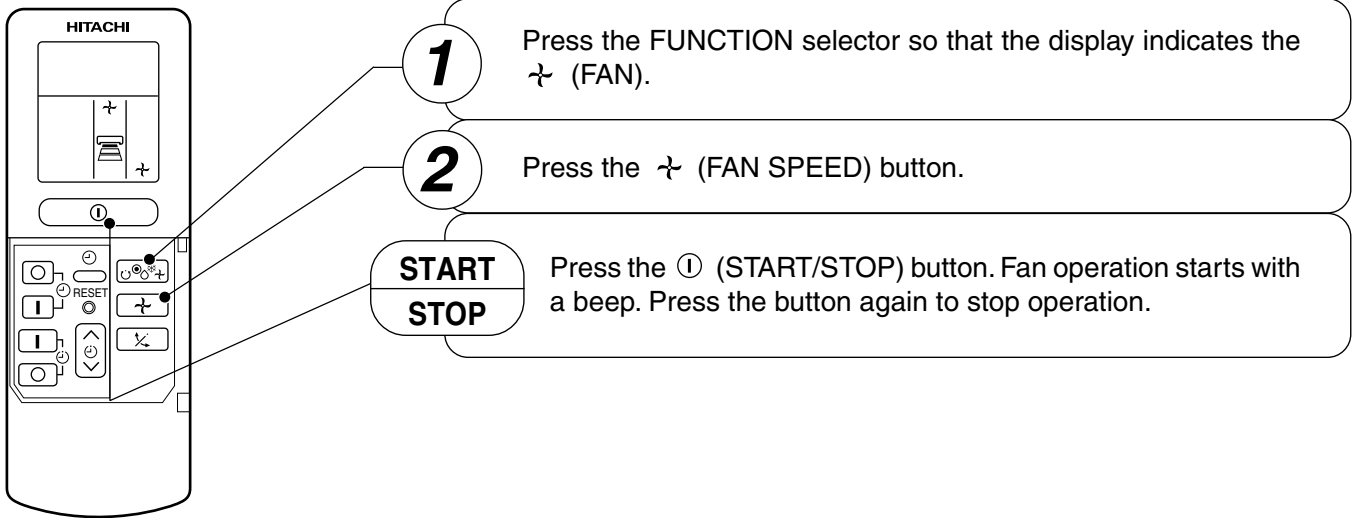

FAN SPEED (AUTO) ... When the AUTO fan speed mode is set in the cooling/heating operation:

For the heating operation	<ul style="list-style-type: none"> ● The fan speed will automatically change according to the temperature of discharged air. ● When the difference of room temperature and setting temperature is large, fan starts to run at HI speed. ● When the room temperature reaches setting temperature, fan speed changes to LOW automatically.
For the cooling operation	<ul style="list-style-type: none"> ● When the difference of room temperature and setting temperature is large, fan starts to run at HI speed. ● After room temperature reaches the preset temperature, the cooling operation, which changes the fan speed and room temperature to obtain optimum conditions for natural healthful cooling will be performed.

HOW TO SET THE TIMER

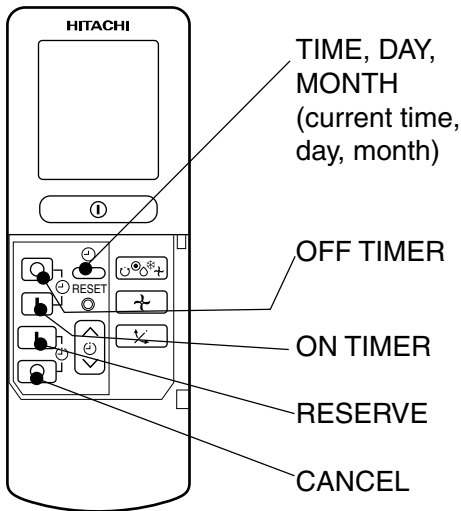

Time, Day, Month

After you change the batteries;

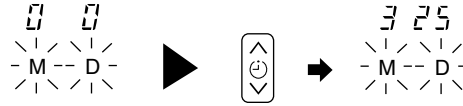

1 Set the current month and day with the TIMER control button.

OFF-Timer

1 Press the (OFF-TIMER) button. The (OFF) mark blinks on the display.

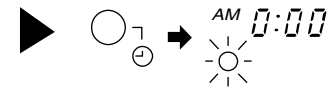
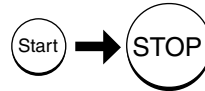

You can set the device to turn off at the present time.

ON-Timer

- The device will turn on at the designated times.

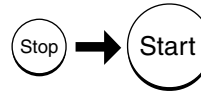

1 Press the (ON-TIMER) button the (ON) mark blinks on the display.

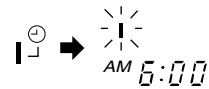

ON/OFF-Timer

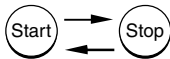

- The device will turn on (off) and off (on) at the designated times.
- The switching occurs first at the preset time that comes earlier.
- The arrow mark appearing on the display indicates the sequence of switching operations.

1 Press the (ON-OFF) button so that the (OFF) mark blinks.

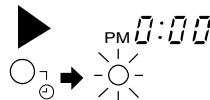

2 Set the turn-off time with the TIMER control button. Press the (RESERVE) button.

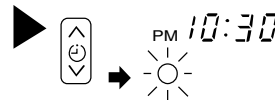

3 Press the (ON-TIMER) button so that the (OFF) mark lights and the (ON) mark blinks.

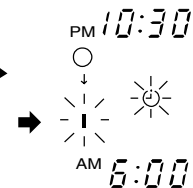

How to Cancel Reservation

Point the signal window of the remote controller toward the indoor unit, and press the (CANCEL) button.

The (RESERVED) sign goes out with a beep and the (TIMER) lamp turns off on the indoor unit.

NOTE

You can set only one of the OFF-timer, ON-timer and ON/OFF-timer.

2 Press the  (TIME) button.

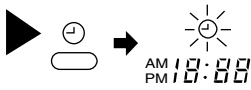

3 Set the current time with the TIMER control button.

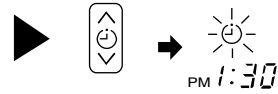

4 Press the  (TIME) button again. The time indication starts lighting instead of flashing.

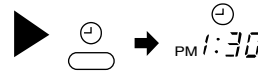



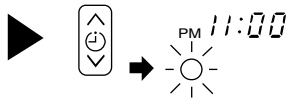

- The time indication will disappear automatically in 10 second.
- To check the current time setting, press the  (TIME) button twice. The setting of the current time is now complete.

Example: The current time is 1:30 p.m.

2 Set the turn-off time with the TIMER control button.



3 Point the signal window of the remote controller toward the indoor unit, and press the  (RESERVE) button.

The  (OFF) mark starts lighting instead of flashing and the sign  (RESERVED) lights. A beep occurs and the  (TIMER) lamp lights on the indoor unit.

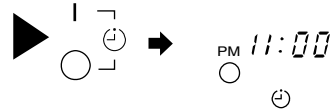





Example: The device will turn off at 11:00p.m.

The setting of turn-off time is now complete.

2 Set the turn-on time with the TIMER control button.



3 Point the signal window of the remote controller toward the indoor unit, and press the  (RESERVE) button.

The  (ON) mark starts lighting instead of flashing and the sign  (RESERVED) lights. A beep occurs and the  (TIMER) lamp lights on the indoor unit.

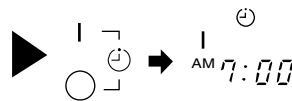



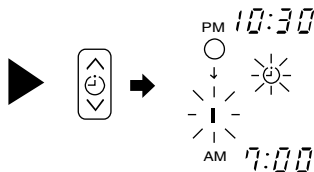

Example:

The device will automatically turn on earlier so that the preset temperature can be reached at 7:00 a.m. The setting of the turn-on time is now complete.

4 Set the turn-on time with the TIMER control button.



5 Point the signal window of the remote controller toward the indoor unit, and press the  (RESERVE) button.

The  (ON) mark starts lighting instead of flashing and the sign  (RESERVED) lights. A beep occurs and the  (TIMER) lamp lights on the indoor unit.

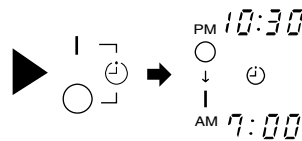

Example:

The device will turn off at 10:30 p.m. and then automatically turn on earlier so that the preset temperature can be reached at 7:00 a.m. The settings of the turn-on/off times are now complete.

- The timer may be used in three ways: off-timer, on-timer and ON/OFF (OFF/ON)-timer. Set the current time at first because it serves as a reference.
- As the time settings are stored in memory in the remote controller, you only have to press the  (RESERVE) button in order to use the same settings next time.

HOW TO SET THE SLEEP TIMER

Set the current time at first if it is not set before (see the pages for setting the current time). Press the  (SLEEP) button, and the display changes as shown below.

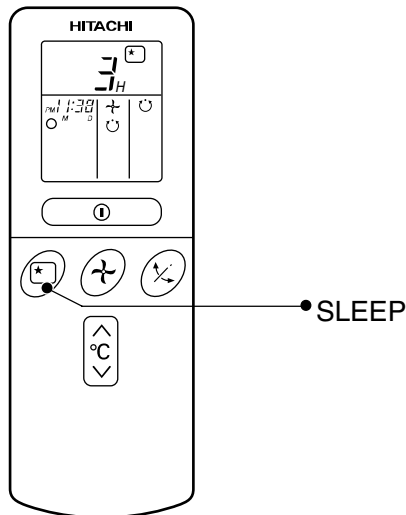

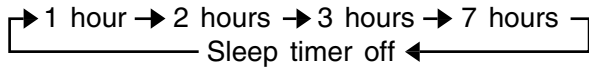
Mode	Indication
Sleep timer	

Sleep Timer: The device will continue working for the designated number of hours and then turn off.

Point the signal window of the remote controller toward the indoor unit, and press the SLEEP button.

The timer information will be displayed on the remote controller. The TIMER lamp lights with a beep from the indoor unit. When the sleep timer has been set, the display indicates the turn-off time.

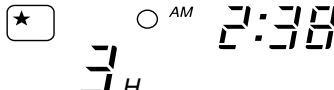
 Example: If you set 3 hours sleep time at 11:38 p.m., the turn-off time is 2:38 a.m.

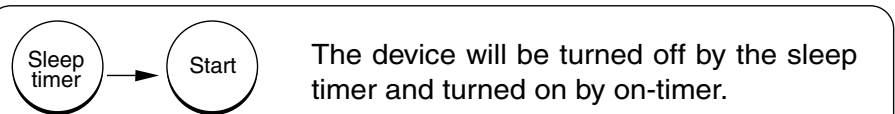

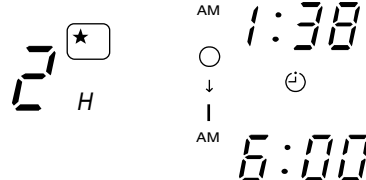

1 Set the On-timer.

2 Press the  (SLEEP) button and set the sleep timer.

 Example:
In this case, the device will turn off in 2 hours (at 1:38 a.m.) and turn on early so that the preset temperature will be almost reached at 6:00 next morning.

How to Cancel Reservation

Point the signal window of the remote controller toward the indoor unit, and press the  (CANCEL) button.

The  (RESERVED) sign goes out with a beep and the  (TIMER) lamp turns off on the indoor unit.

Explanation of the sleep timer

The device will control the FAN SPEED and room temperature automatically so as to be quiet and good for people's health.

You can set the sleep timer to turn off after 1, 2, 3 or 7 hours. The FAN SPEED and room temperature will be controlled as shown below.

Operation with the sleep timer

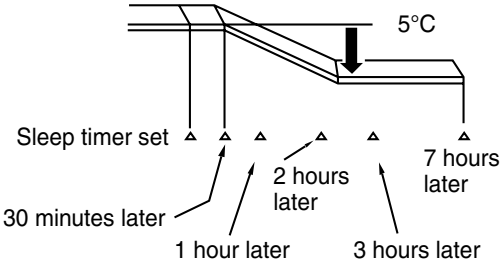
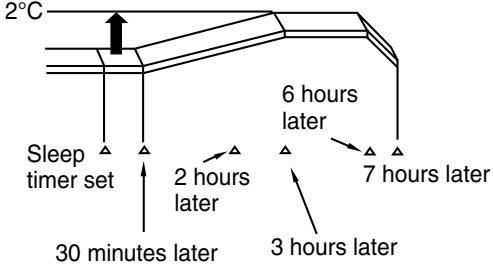
Function	Operation
Heating “ ☉ ”	<p>The room temperature will be controlled 5°C below the temperature and the FAN SPEED will be set to LOW setting 30 minutes after the setting of the sleep timer.</p> 
Cooling “ ❄ ” and dehumidifying “ 💧 ”	<p>The room temperature will be controlled 2°C above the temperature and the FAN SPEED will be set to LOW setting 30 minutes after the setting of the sleep timer.</p> 
Fan “ ✚ ”	<p>The settings of room temperature and circulation are varied.</p>

NOTE

- If date or current time is not set, sleep timer can not be set.
- If you set the sleep timer after the off-, on/off- or off/on-timer has been set, the sleep timer becomes effective instead of the off-, on/off- or off/on-timer set earlier.
- You can not set other timer during sleep timer operation.
- After sleep timer time is up and when press sleep button again, the sleep timer will be set as last setting.
- Sleep timer effective only once.

ADJUSTING THE AIR DEFLECTORS

- 1** Adjustment of the conditioned air in the upward and downward directions.

According to “Dehumidifying” and “Cooling” operation, the horizontal air deflector is automatically set to the proper angle suitable for each operation.

The deflector can be swung up and down and also set to the desired angle using the “ (AUTO SWING)” button. (If the angle of the deflector is changed, it will not return to the auto-set position after operations start unless the operation mode is switched.)

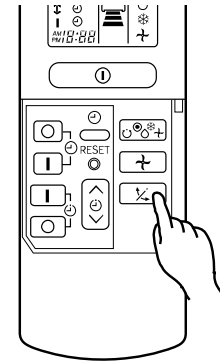

- If the “ (AUTO SWING)” button is pressed once, the horizontal air deflector swings up and down. If the button is pressed again, the deflector stops in its current position. Several seconds (about 12 seconds) may be required before the deflector starts to move.
- In “Cooling” operation, do not keep the horizontal air deflector swinging for a long time. Some dew may form on the horizontal air deflector and some dew may drop.

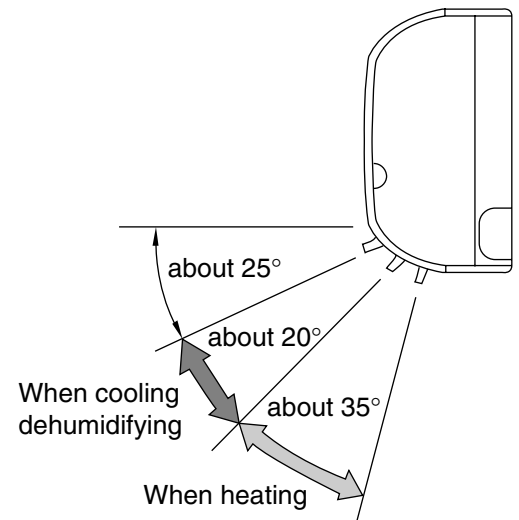

- 2** Adjustment of the conditioned air to the left and right.

Hold the vertical air deflector as shown in the figure and adjust the conditioned air to the left and right.

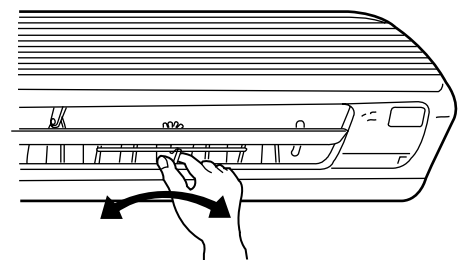

CAUTION

- When operating the unit in cooling operation with the air deflector facing down and moving automatically for a long period of time, water will condensed on the air deflector and drips down occasionally. This will wet your furniture.

HOW TO EXCHANGE THE BATTERIES IN THE REMOTE CONTROLLER

- 1** Remove the cover as shown in the figure and take out the old batteries.



- 2** Install the new batteries.
The direction of the batteries should match the marks in the case.

⚠ CAUTION

1. Do not use new and old batteries, or different kinds of batteries together.
2. Take out the batteries when you do not use the remote controller for 2 or 3 months.

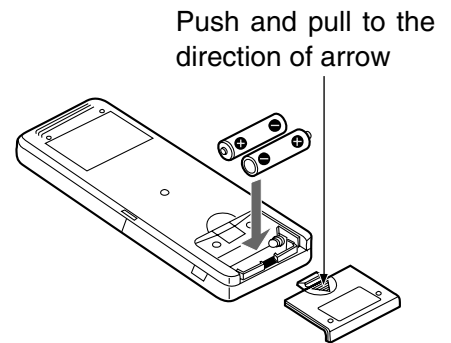

THE IDEAL WAYS OF OPERATION

Suitable Room Temperature



⚠ Warning
Freezing temperature is bad for health and a waste of electric power.

Install curtain or blinds

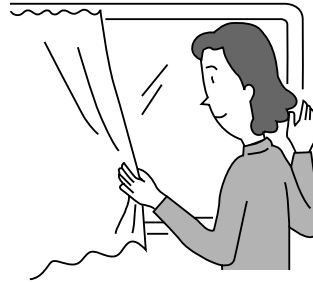

It is possible to reduce heat entering the room through windows.

Ventilation

⚠ Caution
Do not close the room for a long period of time. Occasionally open the door and windows to allow the entrance of fresh air.



Effective Usage Of Timer

At night, please use the "OFF or ON timer operation mode", together with your wake up time in the morning. This will enable you to enjoy a comfortable room temperature. Please use the timer effectively.

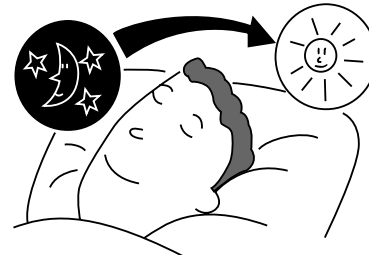

Do Not Forget To Clean The Air Filter

Dusty air filter will reduce the air volume and the cooling efficiency. To prevent from wasting electric energy, please clean the filter every 2 weeks.

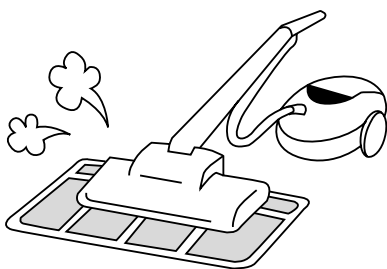

Please Adjust Suitable Temperature For Baby and Children

Please pay attention to the room temperature and air flow direction when operating the unit for baby, children and old folks who have difficulty in movement.

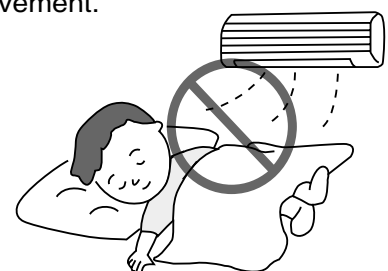

FOR USER'S INFORMATION

The Air Conditioner And The Heat Source In The Room

⚠ Caution

If the amount of heat in the room is above the cooling capability of the air conditioner (for example: more people entering the room, using heating equipments and etc.), the preset room temperature cannot be achieved.

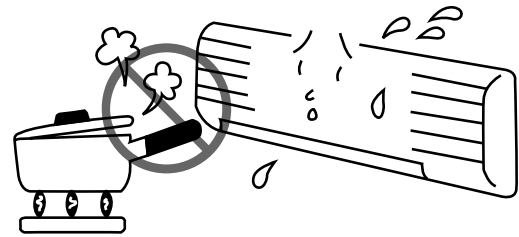

Not Operating For A Long Time

When the indoor unit is not to be used for a long period of time, please switch off the power from the mains. If the power from mains remains "ON", the indoor unit still consumes about 8W in the operation control circuit even if it is in "OFF" mode.

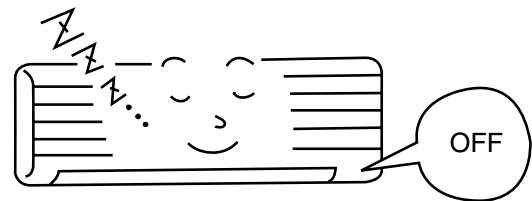

When Lightning Occurs

⚠ Warning

To protect the whole unit during lightning, please stop operating the unit and remove the plug from the socket.

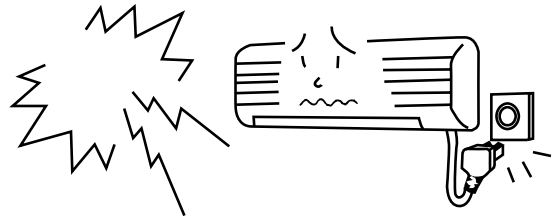

Interference From Electrical Products

⚠ Caution

To avoid noise interference, please place the indoor unit and its remote controller at least 1m away from electrical products.

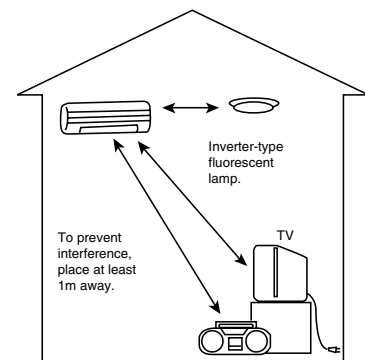

MAINTENANCE

⚠ CAUTION

Before the cleaning, stop operation and disconnect the power supply.

1. AIR FILTER

Clean the air filter, as it removes dust inside the room. In case the air filter is full of dust, the air flow will decrease and the cooling capacity will be reduced. Further, noise may occur. Be sure to clean the filter following the procedure below.

PROCEDURE

1. Remove dust from the filter using a vacuum cleaner. If there is too much dust, use neutral detergent. After using neutral detergent, wash with clean water and dry in the shade.

2. Install the filters.
 (Set them with "FRONT" mark facing front.)
 Slot in the filter to the original state.

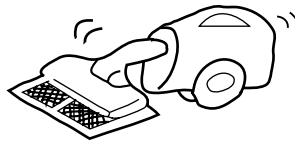

⚠ CAUTION

- Do not wash with hot water at more than 40°C. The filter may shrink.
- When washing it, shake off moisture completely and dry it in the shade; do not expose it directly to the sun. The filter may shrink.
- Do not operate the air conditioner with the filter removed. Dust may enter the air conditioner and cause trouble.

NOTE:

- This model has an air cleaning filter. The cooling capacity is slightly weakened and the cooling speed becomes slower when the air cleaning filter is used. So, set the fan speed to "HIGH" when using it in this condition.
- Recommended to replace the air cleaning filter after every 3 months for normal usage. Type number for this air cleaning filter is <SPX-CFH3>. Please use this number for ordering when you want to renew it.

REMOVING METHOD

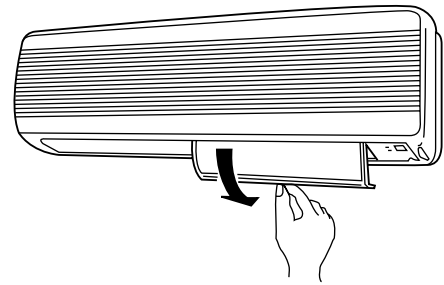

1. Press the "  (AUTO SWING) button, let the deflector facing downward.
2. Remove the filter from the lower side as the arrow shown.

INSTALLATION METHOD

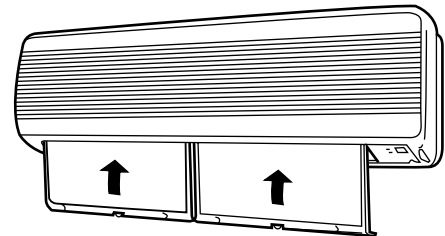

Set the filter with "FRONT" mark facing front, and slot in them to the original state.

2. CLEANING OF FRONT COVER, ETC.

- Wipe it with a soft dry cloth.
- When it is excessively dirty, wipe with a soft cloth soaked in luke warm water or neutral detergent. Then wipe thoroughly with a soft dry cloth.
- Wipe the remote controller thoroughly with a soft dry cloth.



⚠ CAUTION

- Never use hot water (above 40°C), benzine, gasoline, acid, thinner or a brush, because they will damage the plastic surface and the coating.



3. MAINTENANCE AT BEGINNING OF LONG OFF PERIOD

Running the unit setting the operation mode to  (FAN) and the fan speed to HI for about half a day on a fine day, and dry the whole of the unit.

Disconnect the power plug.

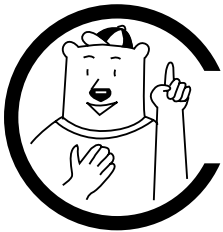
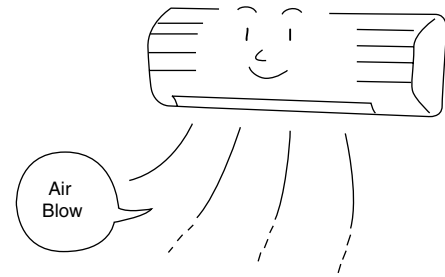

REGULAR INSPECTION

PLEASE CHECK THE FOLLOWING POINTS EVERY EITHER HALF YEARLY OR YEARLY. CONTACT YOUR SALES AGENT SHOULD YOU NEED ANY HELP.

<p>1</p>		<p>Is the plug of power line firmly plugged into the socket? (Please ensure no loose contact between them).</p>
<p>2</p>		<p>Is the earth line disconnected or broken?</p>
<p>3</p>		<p>Is the mounting frame seriously affected by rust and is the outdoor unit tilted or unstable?</p>

AFTER SALES SERVICE AND WARRANTY

WHEN ASKING FOR SERVICE, CHECK THE FOLLOWING POINTS.

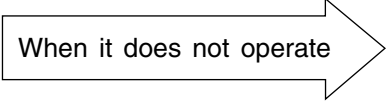
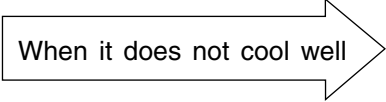
CONDITION	CHECK THE FOLLOWING POINTS
 <p>When it does not operate</p>	<ul style="list-style-type: none"> ● Is the fuse all right? ● Is the voltage extremely high or low? ● Is the circuit breaker "ON"?
 <p>When it does not cool well</p>	<ul style="list-style-type: none"> ● Was the air filter cleaned? ● Does sunlight fall directly on the outdoor unit? ● Is the air flow of the outdoor unit obstructed? ● Are the doors or windows opened, or is there any source of heat in the room? ● Is the set temperature suitable?



Notes

- In quiet operation or stopping the operation, the following phenomena may occasionally occur, but they are not abnormal for the operation.
 - (1) Slight flowing noise of refrigerant in the refrigerating cycle.
 - (2) Slight rubbing noise from the fan casing which is cooled and then gradually warmed as operation stops.
- The odor will possibly be emitted from the room air conditioner because the various odor, emitted by smoke, foodstuffs, cosmetics and so on, sticks to it. So please clean the air filter and the evaporator regularly to reduce the odor.

- Please contact your sales agent immediately if the air conditioner still fails to operate normally after the above inspections. Inform your agent of the model of your unit, production number, date of installation. Please also inform him regarding the fault.
- Power supply shall be connected at the rated voltage, otherwise the unit will be broken or could not reach the specified capacity.

Please note:

On switching on the equipment, particularly when the room light is dimmed, a slight brightness fluctuation may occur. This is of no consequence.
The conditions of the local Power Supply Companies are to be observed.

HOW TO REPLACE NEW UV-LED AND FILTER

1 Open the front cover.

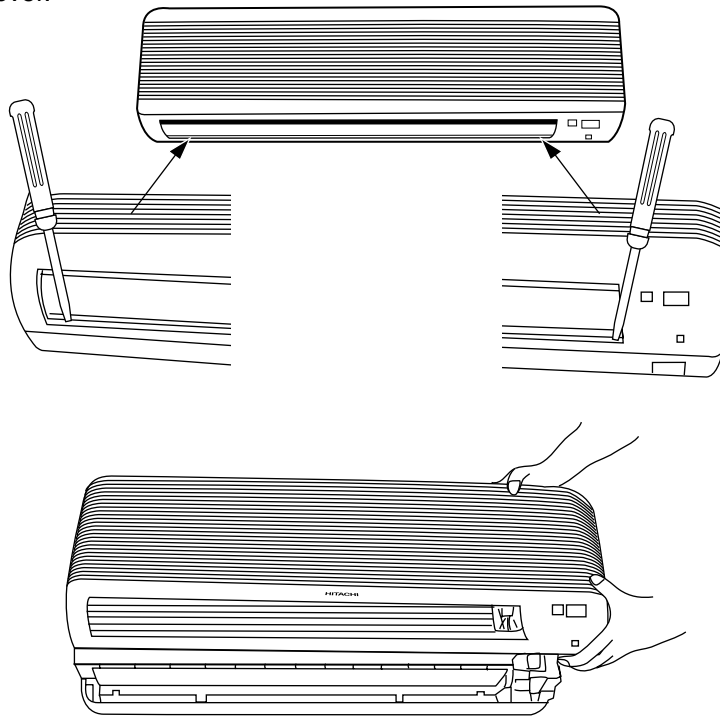

2 Cut the binder.

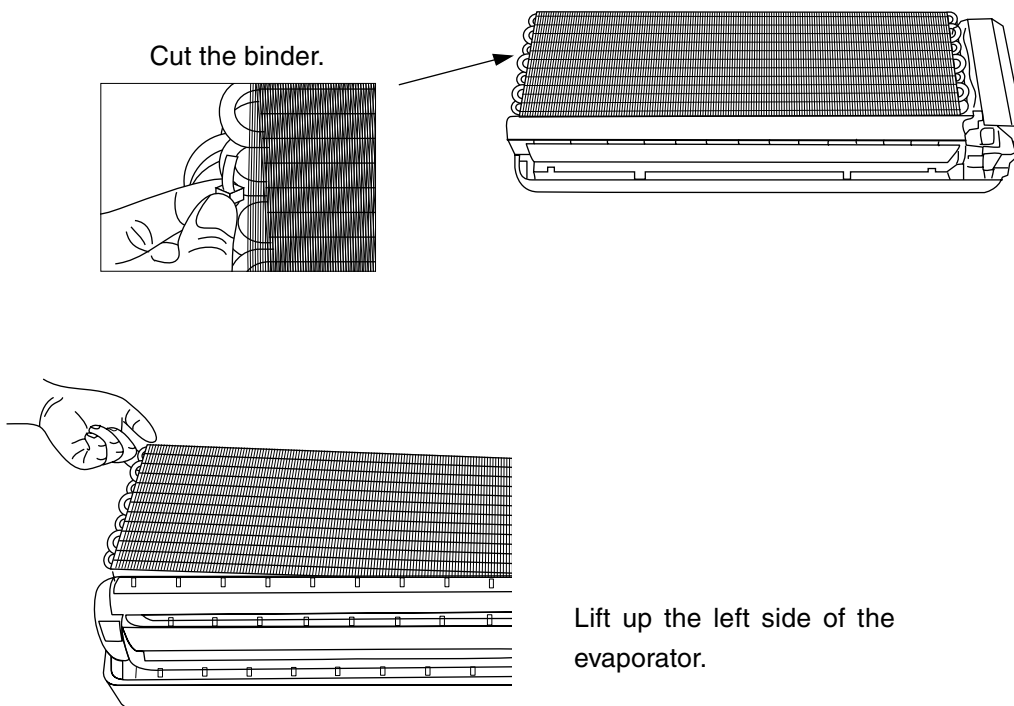

Lift up the left side of the evaporator.

3

Rear view

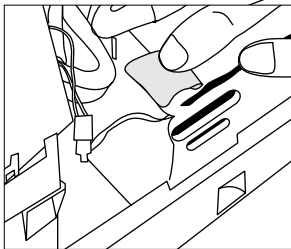
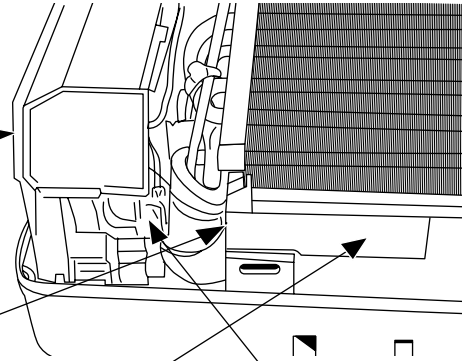
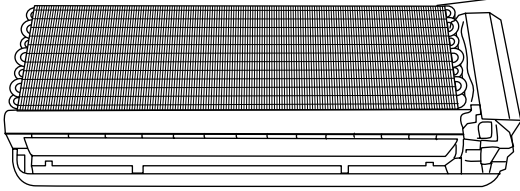

Remove tape at the cabinet.

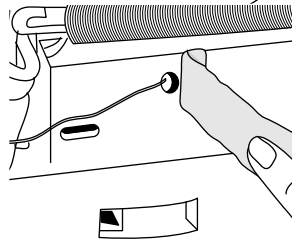

Remove aluminium tape at the cabinet.

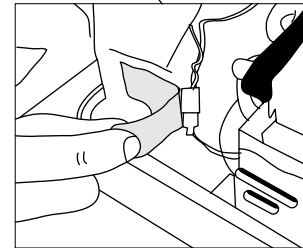

Remove tape at the electrical box.

4

Disconnect the connector between UV-LED and electrical box.

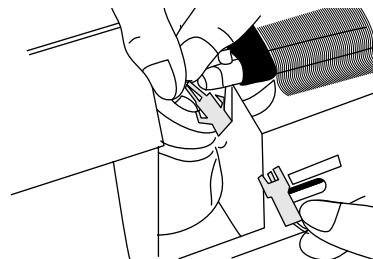

5

Remove the K-spring.

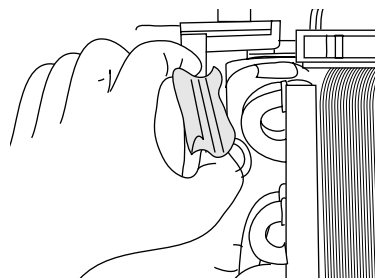

6

Pull up the ACL-holder.

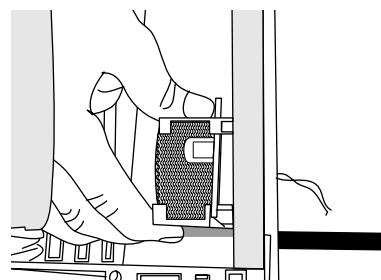

- 7** Remove the UV-LED.

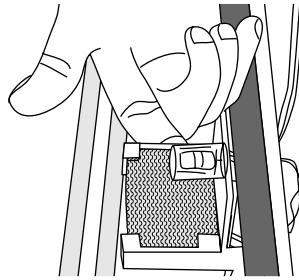

If necessary, change the ACL filter (SPX-CFH9).

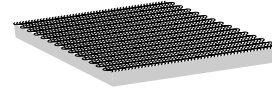

- 8** After replace new UV-LED and filter, make sure to reattach the aluminium tape.

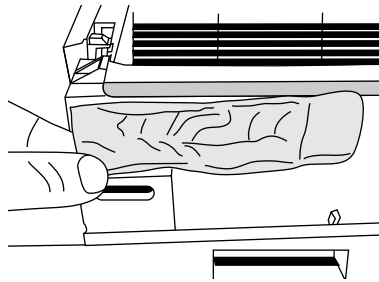

- 9** Put back the K-spring.

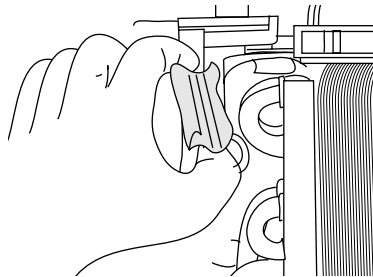

- 10** Connect the connector between UV-LED and electrical box.

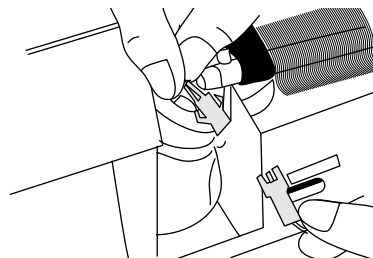

11

Rear view

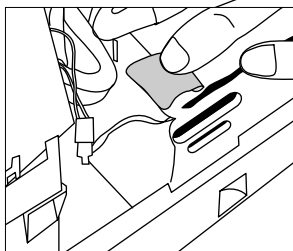
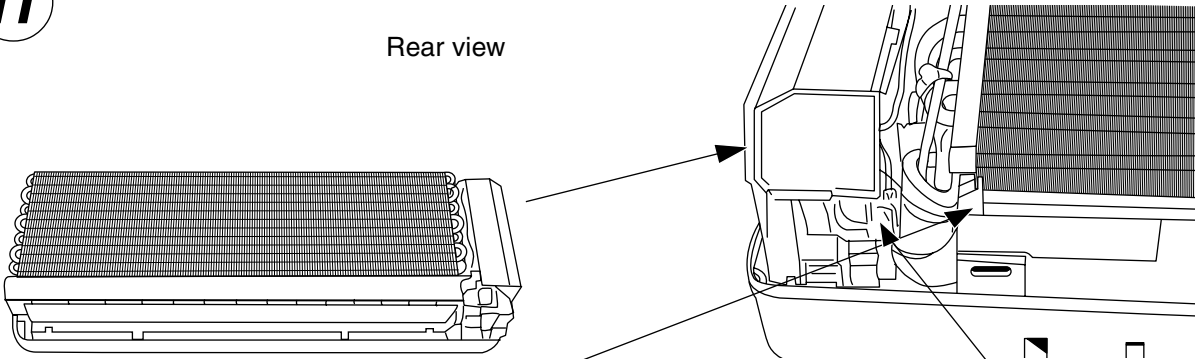

Reattach tape at the cabinet.

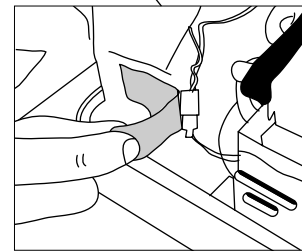

Reattach tape at the electrical box.

12

Reattach the evaporator to its place.

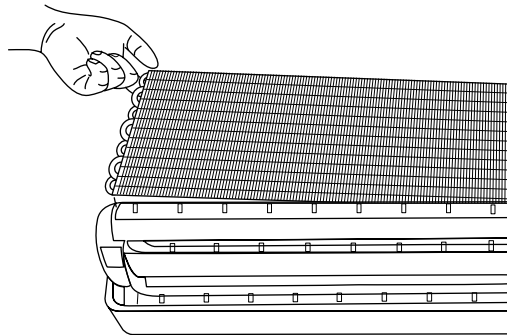

Reattach the binder.

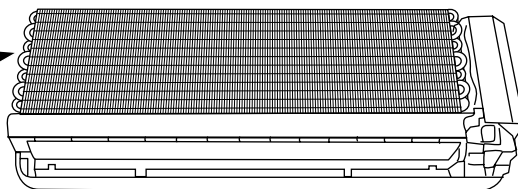

13 Put back the front cover.

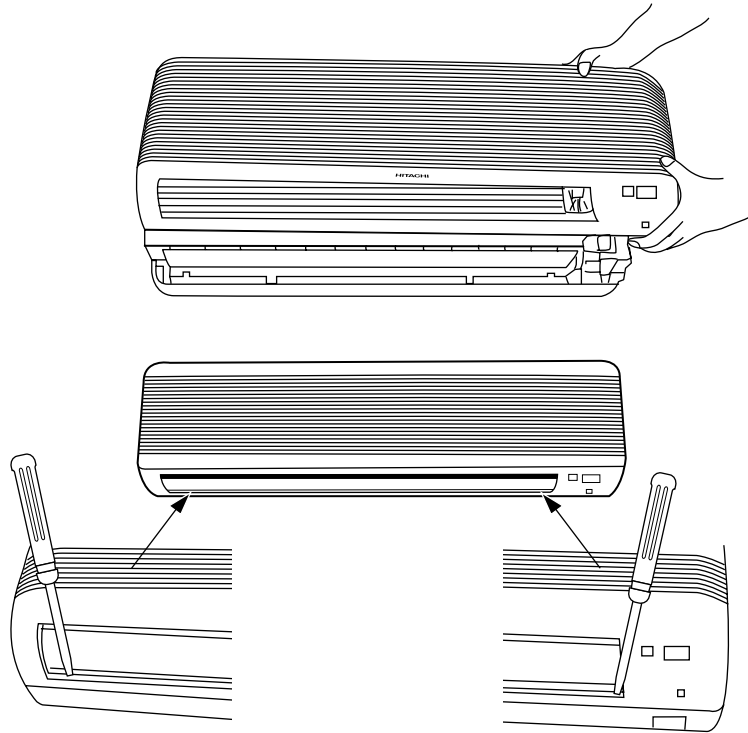

CONSTRUCTION AND DIMENSIONAL DIAGRAM

MODEL RAS-07CH4, RAS-09CH4

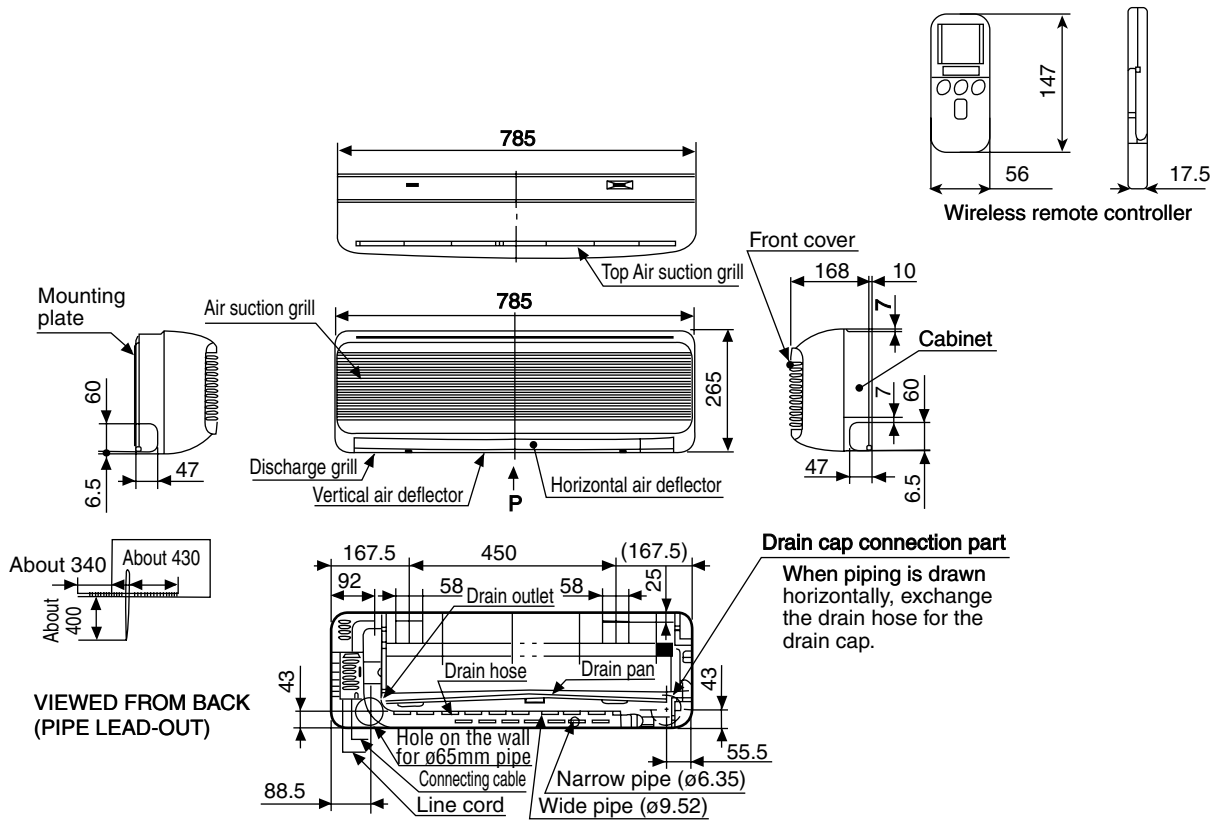

MODEL RAC-07CH4, RAC-09CH4

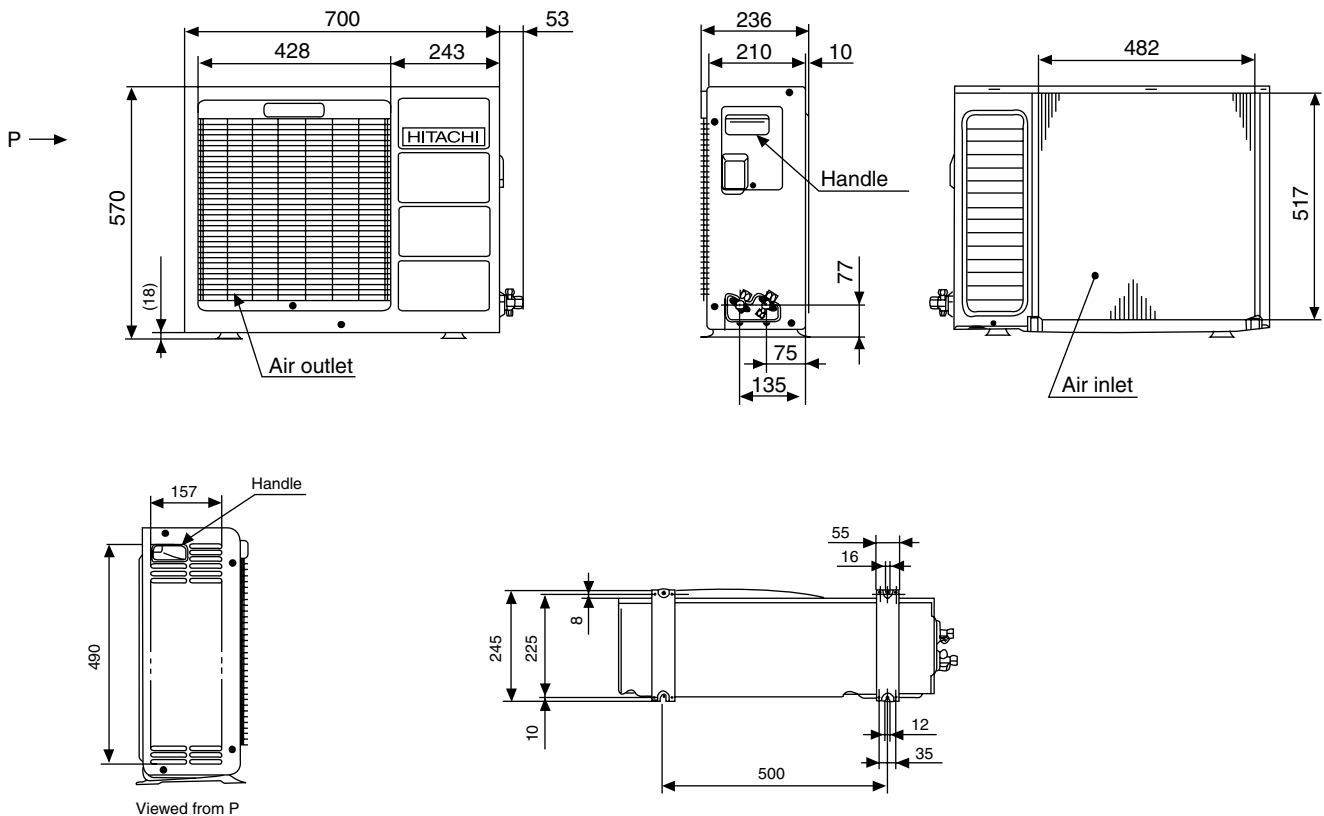

MAIN PARTS COMPONENTS

THERMOSTAT

Thermostat Specifications

MODEL			RAS-07CH4, RAS-09CH4
THERMOSTAT MODEL			IC
TEMPERATURE °C (°F)	INDICATION 16	ON	17.6 (63.7)
		OFF	16.6 (61.8)
	INDICATION 24	ON	25.6 (78.1)
		OFF	24.6 (76.3)
	INDICATION 32	ON	33.6 (92.5)
		OFF	32.6 (90.7)

FAN MOTOR

Fan Motor Specifications

MODEL		RAS-07CH4, RAS-09CH4	RAC-07CH4, RAC-09CH4	
PHASE		SINGLE		
RATED VOLTAGE		220 – 240V		
RATED FREQUENCY		50 Hz		
OUTPUT		10 W	20 W	
POLE NUMBER		4	6	
CONNECTION				
RESISTANCE VALUE (Ω)	20°C (68°F)	M= 541.0 A1 = 148.3	A2 = 87.6 A3 = 147.4	WA = 348.2 WM = 284.6
	25°C (77°F)	M= 551.6 A1 = 151.2	A2 = 89.3 A3 = 150.3	WA = 355 WM = 290.2

COMPRESSOR MOTOR

Compressor Motor Specifications

MODEL		RAC-07CH4	RAC-09CH4
COMPRESSOR MODEL		G333DB2Z	G533QB9Z
PHASE		SINGLE	SINGLE
RATED VOLTAGE		220 – 240 V	220 – 240 V
RATED FREQUENCY		50 Hz	50 Hz
LOCKED ROTOR CURRENT		22 A	22 A
POLE NUMBER		2	2
CONNECTION			
RESISTANCE VALUE (Ω)	20°C (68°F)	RA = 4.072 RM = 3.938	RA = 4.372 RM = 3.154
	75°C (167°F)	RA = 4,896 RM = 3.787	RA = 5.315 RM = 3.834

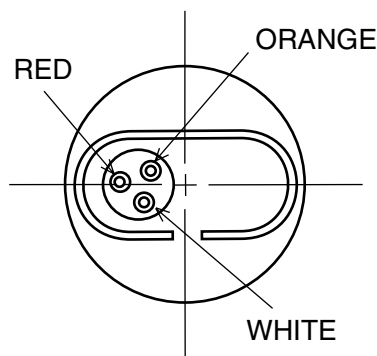

CAUTION

When the Air conditioner has been operated for a long time with the capillary tubes clogged or crushed or with too little refrigerant, check the color of the refrigerating oil inside the compressor. If the color has been changed conspicuously, replace the compressor.

WIRING DIAGRAM

MODEL RAS-07CH4, RAC-07CH4

- | | |
|------------------------------------|---|
| Ⓐ : COMPRESSOR | Ⓝ : REVERSING VALVE |
| Ⓑ : FAN MOTOR | Ⓟ : POWER RELAY |
| Ⓒ : POWER SWITCH | Ⓠ : THERMAL FUSE FOR TERMINAL BOARD |
| Ⓓ : 1,000 PF CAPACITOR | Ⓡ : SURGE ASSORBER |
| Ⓔ : FAN MOTOR PROTECTOR (INTERNAL) | Ⓢ : THERMISTOR |
| Ⓕ : 1 μF CAPACITOR | Ⓣ : TRANSFORMER |
| Ⓖ : 35 μF CAPACITOR | Ⓤ _P : OVERLOAD PROTECTOR |
| Ⓗ : 2.5 μF CAPACITOR | Ⓥ : VARISTOR |
| Ⓘ : FAN MOTOR PROTECTOR | Ⓦ : SOLID STATE RELAY FOR FAN (FAN SSR) |
| Ⓝ : LINE CORD | Ⓧ : FUSE |
| Ⓚ : TERMINAL BOARD | Ⓨ : REVERSING VALVE RELAY |
| Ⓛ : OUTDOOR FAN RELAY | Ⓩ : AUTO SWEEP MOTOR |
| Ⓜ : THERMAL FUSE FOR PCB | |

BLU : BLUE	YEL : YELLOW	BRN : BROWN	WHT : WHITE
GRY : GRAY	ORN : ORANGE	GRN : GREEN	RED : RED
BLK : BLACK	PNK : PINK	VIO : VIOLET	

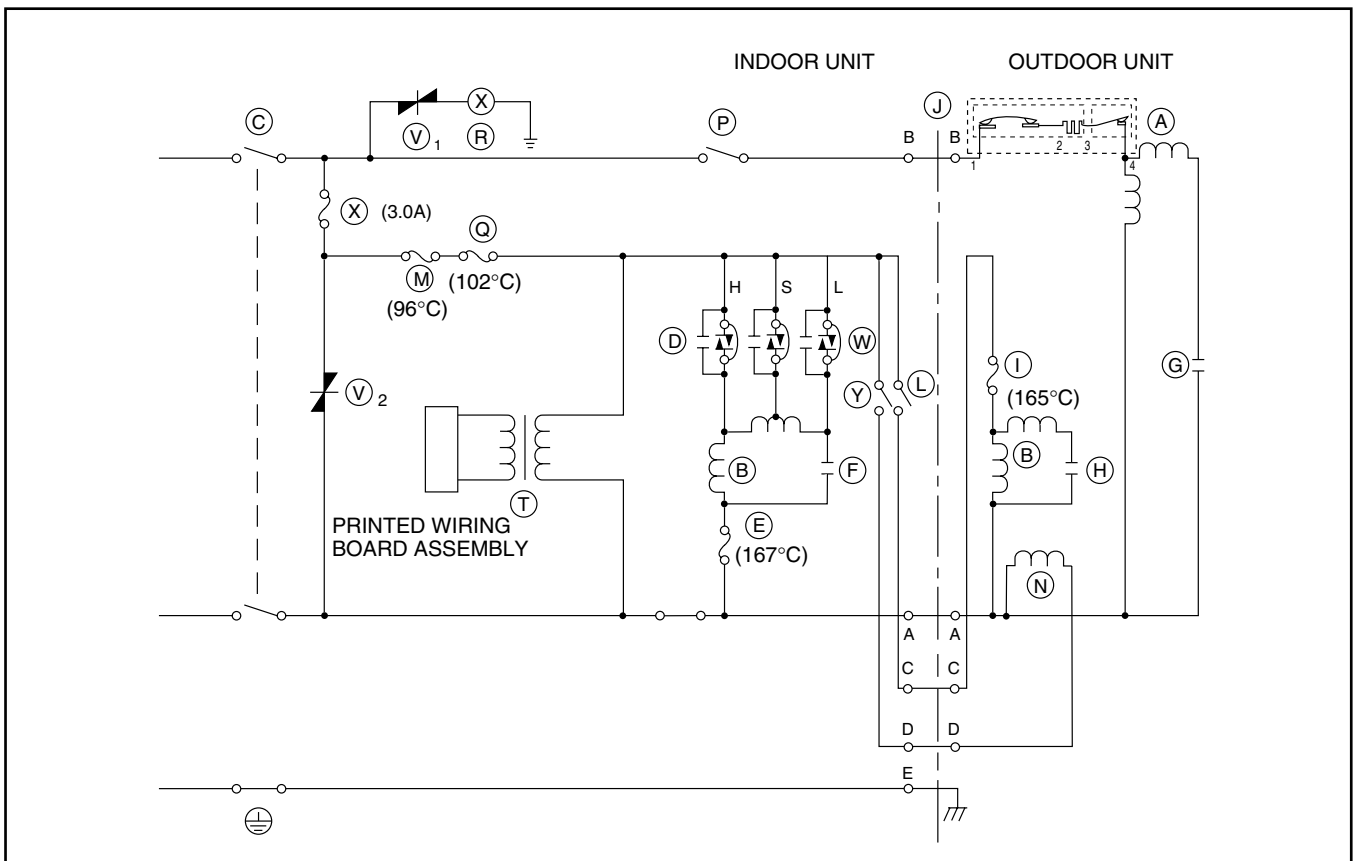

OUTDOOR UNIT

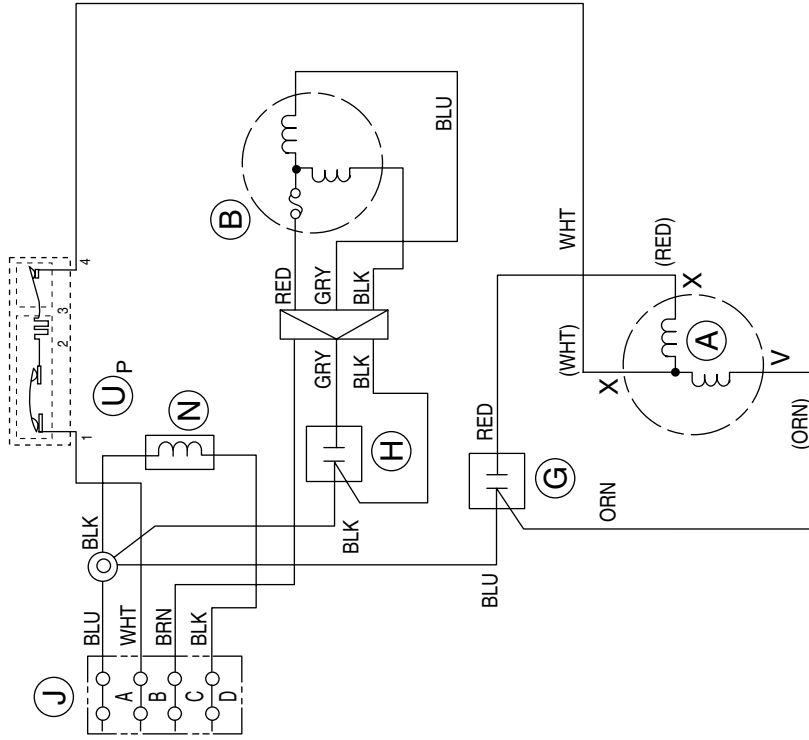

INDOOR UNIT

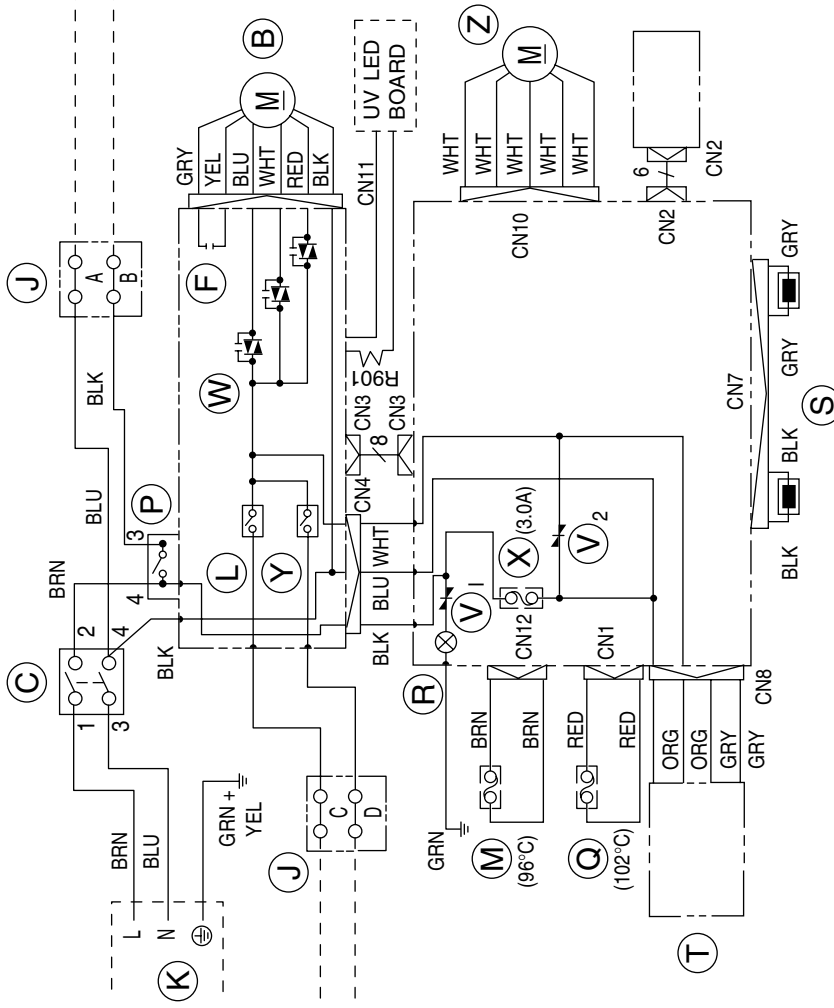

GRY + YEL

⊕

MODEL RAS-07CH4, RAS-09CH4

RESISTOR

SYMBOL	RESISTANCE	TOLERANCE	POWER	FORM
R201	3K	±5%	1/10W	C
R202	10K	±5%	1/16W	C
R203	2.7K	±5%	1/16W	C
R204	5.1K	±5%	1/16W	C
R205	5.1K	±5%	1/16W	C
R206	10K	±5%	1/16W	C
R207	10K	±5%	1/16W	C
R210	1M	±5%	1/16W	C
R302	1K	±5%	1/16W	C
R303	10K	±5%	1/16W	C
R304	2.4K	±2%	1/16W	C
R307	1K	±5%	1/16W	C
R308	18K	±1%	1/10W	C
R309	1K	±5%	1/16W	C
R310	127K	±1%	1/10W	C
R311	1K	±5%	1/16W	C
R312	10K	±5%	1/16W	C
R313	10K	±5%	1/16W	C
R314	10K	±5%	1/16W	C

SYMBOL	RESISTANCE	TOLERANCE	POWER	FORM
R401	390	±5%	1/16W	C
R402	390	±5%	1/16W	C
R403	390	±5%	1/16W	C
R404	390	±5%	1/16W	C
R405	5.1K	±5%	1/16W	C
R406	5.1K	±5%	1/16W	C
R410	10K	±5%	1/16W	C
R411	10K	±5%	1/16W	C
R412	10K	±5%	1/16W	C
R413	10K	±5%	1/16W	C
R414	10K	±2%	1/16W	C
R501	560	±5%	1/10W	C
R502	560	±5%	1/10W	C
R503	560	±5%	1/10W	C
R504	560	±5%	1/10W	C
R505	560	±5%	1/10W	C
R506	560	±5%	1/10W	C

SYMBOL	RESISTANCE	TOLERANCE	POWER	FORM
R601	10K	±5%	1/16W	C
R603	10K	±5%	1/16W	C
R606	10K	±5%	1/16W	C
R607	10K	±5%	1/16W	C
R608	1K	±5%	1/16W	C
R609	1K	±5%	1/16W	C
R610	1K	±5%	1/16W	C
R611	10K	±5%	1/16W	C
R612	1K	±5%	1/16W	C
R613	10K	±5%	1/16W	C
R614	5.1K	±5%	1/16W	C
R702	240	±5%	1/10W	C
R703	240	±5%	1/10W	C
R705	1K	±1%	1/16W	C
R707	20	±5%	1/10W	C
R708	20	±1%	1/10W	C
R801	3.3K	±5%	1/10W	C
R901	750	±5%	1/4W	H

CAPACITOR

SYMBOL	RATING	TYPE	FORM
C101	1000µ, 35V	D (VX)	H
C102			
C103	100µ, 16V	D (VX)	H
C104			
C105			
C106	100µ, 10V	D (VX)	H
C201	33µ, 6.3V	D (VX)	H
C202	0.1µ, 25V	C	C
C205	0.1µ, 25V	C	C
C206	0.1µ, 25V	C	C
C301	0.1µ, 25V	C	C
C302	0.1µ, 25V	C	C
C303	0.1µ, 25V	C	C
C401	0.1µ, 25V	C	C
C501	1000P, AC250V	C	H
C502	1000P, AC250V	C	H
C503	1000P, AC250V	C	H
C504	1µ, 400VAC	F	H
C601	0.1µ, 25V	C	C
C701	33µ, 10V	D (WX)	C
C801	1000P, 50V	C	C

OSCILLATOR

SYMBOL	MODEL NO.	FORM
OSC1	EFOEC8004A4	H

TRANSISTOR

SYMBOL	MODEL NO.	FORM
Q201	2SC2462LC	C
Q202	2SA1121SCT	C
Q301	GA1A4M	C
Q302	DTC114EUA	C
Q501	GA1A4M	C
Q502	GA1A4M	C
Q503	GA1A4M	C

DIODE

SYMBOL	MODEL NO.	FORM
DB101	S1WB20	H
D401	DAN202K	C
D403	DAP202K	C

SURGE PROTECTORS

SYMBOL	MODEL NO.	FORM
VARIATOR 1	450NR12D	H
VARIATOR 2	450NR12D	H
SURGE ABSORBER	DSA-362MA-05	H

RELAYS

SYMBOL	MODEL NO.	FORM
POWER RELAY	DFT-RELAY	H
OUTDOOR FAN RELAY	G5N-RELAY	H
REVERSING VALVE RELAY	G5N-RELAY	H

IC

SYMBOL	MODEL NO.	FORM
REG1	MC7&12CT	H
REG2	MC7&05CT	H
IC1	HD6433712	C
IC401	BR24C02F	C
IC501	ULN2003ANS	C
SSR-H	TLP3507	H
SSR-L	TLP3507	H
SSR-S	TLP3507	H
IR701	RPM6938-V4	H

NOTES:

1. TYPE OF CAPACITOR

F : FILM
C : CERAMIC
D : ELECTROLYTIC

2. FORM

H : HAND INSERT
C : SMT
R : RADIAL
A : AXIAL

SWITCHES

SYMBOL	MODEL NO.	FORM
SW701	EVQP05R-SW	H
SERVICE SW	SSSS9AE	H

BUZZER

SYMBOL	MODEL NO.	FORM
BZ1	PKM13EPY	H

ZENER DIODE

SYMBOL	MODEL NO.	FORM
ZD201	RLZB.8A	C

LED

SYMBOL	MODEL NO.	COLOUR	FORM
LD702	SLR-332DC3F	ORANGE	H
LD703	SLR-332YC3F	YELLOW	H

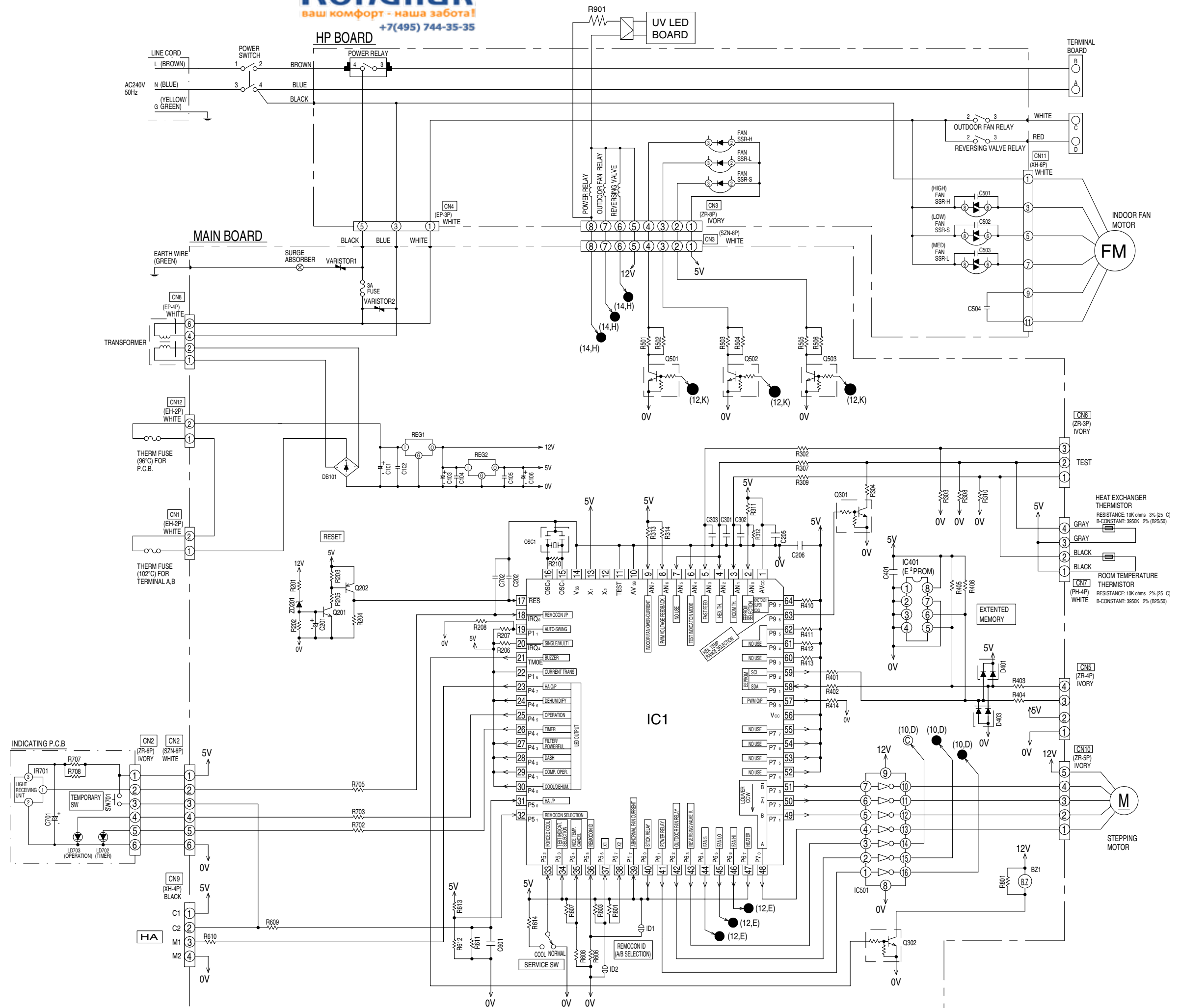

BASIC MODE

Operation mode		Fan	Cooling	Sensor dehumidification	Heating	Automatic																											
1	Control function																																
1	Start/stop button, basic mode			Start/stop button operation lamp	Start/stop button operation lamp	Start/stop button operation lamp																											
2	Timer operation	OFF timer		Start/stop button Reservation Cancel Operation lamp Timer lamp Timer memory	Start/stop button Reservation Cancel Operation lamp Timer lamp Timer memory	Start/stop button Reservation Cancel Operation lamp Timer lamp Timer memory																											
2		ON timer		Start/stop button Reservation Cancel Operation lamp Timer lamp Timer memory	Start/stop button Reservation Cancel Operation lamp Timer lamp Timer memory	Start/stop button Reservation Cancel Operation lamp Timer lamp Timer memory																											
3	Circulation mode	Automatic	• Operation in the previous circulation mode	• "HI", "MED", or "LO" operation is executed according to the thermostat signal. (Refer to "Thermostat operation".)	• "HI", "MED", "LO", and "Stop" are repeated according to the thermostat signal and time.	• The "Automatic" speed mode for each operation mode is used independent of the setting. "Week" at the time of "Sensor dehumidification".)																											
3		HI	• Operation in "HI" mode	• Same as on the left.	• "HI", "MED", "LO", and "Stop" are repeated according to the thermostat signal and time.																												
3		MED	• Operation in "MED" mode	• Same as on the left.	• "MED", "LO", and "Stop" are repeated according to the thermostat signal and time.																												
3	LO	• Operation in "LO" mode	• Same as on the left.	• "LO" and "Stop" are repeated according to the thermostat signal and time.																													
4	Thermostat operation		<p>• Only circulation with cut velocity is executed, independent of the thermostat signal.</p> <p>(1) Strong</p> <p>• The power relay is delayed by 2 seconds from the start of thermostat operation.</p>	<p>(1) When the set temperature is lower than the room temperature</p> <p>• The min. ON time of the power relay is 3 minutes, and the min. OFF time also is 3 minutes.</p> <p>• The indoor fan is not delayed with operation start by start/stop button ON.</p> <p>• The indoor fan is delayed by 5 sec with operation start by thermostat operation.</p> <p>(2) Set temperature higher than room temperature</p> <p>Notes:</p> <ul style="list-style-type: none"> Forced operation by start/stop button ON is executed even with thermostat OFF. The room temperature 30 sec after operation start, minus 0.66 deg, becomes the set temperature. When the room temperature is 16°C or lower, 16°C becomes the set temperature. The other operations are the same as for (1). 	<p>Example for "HI" circulation mode</p> <table border="1"> <thead> <tr> <th>Air-blow mode</th> <th>(A)</th> <th>(B)</th> </tr> </thead> <tbody> <tr> <td>H</td> <td>L</td> <td>H</td> </tr> <tr> <td>L</td> <td>L</td> <td>L</td> </tr> <tr> <td>S</td> <td>S</td> <td>S</td> </tr> <tr> <td>Automatic</td> <td>L</td> <td>*L</td> </tr> </tbody> </table> <p>Notes:</p> <ul style="list-style-type: none"> The min. ON time of the power relay is 3 minutes, and the min. OFF time also is 3 minutes. In automatic circulation mode, "HI" in section (B) occurs only the first time. 	Air-blow mode	(A)	(B)	H	L	H	L	L	L	S	S	S	Automatic	L	*L	<p>• The operation mode at the start of operation differs as shown below according to the room temperature.</p> <table border="1"> <thead> <tr> <th>Room temperature at the start of operation</th> <th>Cooling</th> <th>Sensor dehumidification</th> <th>Heating</th> </tr> </thead> <tbody> <tr> <td>27°C</td> <td>The set temperature shall be 27°C.</td> <td>The set temperature shall be 2 degrees below the room temperature at the start of operation.</td> <td></td> </tr> <tr> <td>23°C</td> <td></td> <td></td> <td>The temperature shall be 23°C + temperature shift amount.</td> </tr> </tbody> </table> <ul style="list-style-type: none"> A shift is not accepted at the time of operation start. There is no switching between modes after start of operation. When the operation is started again within 20 min. after stop with the start/stop button, operation will be executed in the previous mode. The operation details are the same as for each operation mode. The set temperature is set with the room temperature adjustment button. Correction by $\pm 3^\circ\text{C}$ is possible with. At this time, the operation mode judgement temperature also is shifted at the same time. However, correction is possible only in cooling operation mode, but not in "Sensor dehumidification" mode. 	Room temperature at the start of operation	Cooling	Sensor dehumidification	Heating	27°C	The set temperature shall be 27°C.	The set temperature shall be 2 degrees below the room temperature at the start of operation.		23°C			The temperature shall be 23°C + temperature shift amount.
Air-blow mode	(A)	(B)																															
H	L	H																															
L	L	L																															
S	S	S																															
Automatic	L	*L																															
Room temperature at the start of operation	Cooling	Sensor dehumidification	Heating																														
27°C	The set temperature shall be 27°C.	The set temperature shall be 2 degrees below the room temperature at the start of operation.																															
23°C			The temperature shall be 23°C + temperature shift amount.																														

5	Heating load reduction and Pd cut	<p>AIR BLOW CHANGE TO "H" FORCIBLY BY INPUTING "PD CUT 2" AIR BLOW MAKE A POSSIBLE TO CHANGE AIR BLOW AT TEMP. T7. AIR BLOW RETURN TO THE ORIGINAL SETTED TEMP. AT TEMP. T5.</p>
6	Reversing valve lock protection	<ul style="list-style-type: none"> All relays are stopped by low-temperature input. Not accepted during hot keep, during compressor stop, during defrosting and during forced 3 minutes. Accepted only during heating operation. Recovery at the time of stop by low-temperature input is reset recovery. The timer lamp flashes at the time of stop.

Operation mode	Fan	Cooling	Sensor dehumidification	Heating	Automatic							
	Control function											
7				<p>Notes:</p> <ul style="list-style-type: none"> Even when the preheating signal is not given as input, heating operation is started when 3 minutes have passed for T. Preheating operation is executed at the time of operation start and after completion of defrosting, and at all other times, there is no operation, independent of the preheating signal. 	<ul style="list-style-type: none"> At the time of heating operation mode, the same operation as for heating is executed. 							
8			<table border="1"> <tr> <td>TA (Reverse cycle defrosting)</td> <td>10 min. 1/3 min.</td> </tr> <tr> <td>TB (Silencing period)</td> <td>30 sec</td> </tr> <tr> <td>TC (Cycle balancing time)</td> <td>30 sec</td> </tr> <tr> <td>TE (Defrosting prohibition time)</td> <td>60 min. 1/3 min.</td> </tr> </table> <p>Notes:</p> <ul style="list-style-type: none"> For the time TE after start of heating operation, defrosting will not be executed even when the defrosting signal is given as input. When the reserve cycle defrosting TA has continued for the time shown in the table on the left, the operation advances to TB and TC independent of the defrosting signal. When the power relay becomes ON after expiration of the time TE, defrosting will be started immediately with input of the defrosting signal. Once defrosting has been completed, the defrosting signal is not accepted for the time TE. When a defrosting signal has been given as input at the time of stop by means of the start/stop switch or at the time of OFF timer count-up, defrosting is executed before operation stop. The defrosting signal is not accepted at the time of overload input. 	TA (Reverse cycle defrosting)	10 min. 1/3 min.	TB (Silencing period)	30 sec	TC (Cycle balancing time)	30 sec	TE (Defrosting prohibition time)	60 min. 1/3 min.	<p>Notes:</p> <ul style="list-style-type: none"> Defrosting of each operation mode is executed.
TA (Reverse cycle defrosting)	10 min. 1/3 min.											
TB (Silencing period)	30 sec											
TC (Cycle balancing time)	30 sec											
TE (Defrosting prohibition time)	60 min. 1/3 min.											

Table 1 Specifications

Item	Automatic	Yes
Operation switching	Automatic	Yes
	Heating	Yes
	Fan	Yes
	Sensor dehumidification	Yes
	Cooling	Yes
Temporary switch	Yes (automatic)	
Service switch	Heating	Yes
	Cooling	Yes
Nice temperature reservation	Yes	
Automatic fresh defrosting	Yes	
Defrosting	Yes	
Pd cut 1	Yes	
Pd cut 2	Yes	
Pd cut 3	Yes	
Heating load reduction	Yes	
External fan relay	Yes	
Reversing valve relay	Yes	
Reversing valve lock protection	Yes	
Sleep circuit	Yes	
Heater operation at the time of sensor dehumidification	No	
Automatic blowing direction	Yes	
Filter sign	No	
Wireless mode	Heating wireless	

Table 2 Sensor operation values

Item	ON temperature (Thermostat relay) power relay (°C)	Cooling, Sensor dehumidification	16	17.6
Thermostat operation	Differential (°C)	Heating	24	25.6
			32	33.6
			16	19.6
			24	27.6
			32	35.6
				0.33
				-
				-
Low-temperature defrosting	(T1)	ON (°C)	5.0	9.0
Preheating		Reset (°C)	17.0	15.0
		ON (°C)	15.0	-
				-
Pd cut 1	(T3)	ON (°C)	48.66	45.66
		Reset (°C)	45.66	55.0
Pd cut 2	(T6)	ON (°C)	55.0	49.0
		Reset (°C)	49.0	35.0
		(T5) Fan Relay H → Original (°C)	35.0	63.0
Pd cut 3	(T8)	ON (°C)	63.0	55.0
		Reset (°C)	55.0	-





Other detailed specifications

- When the room temperature rises within 3 minutes after thermostat OFF during cooling operation with automatic velocity, the blowing velocity changes in the order of S ← L → H in the same way as at the time of thermostat ON.
- In case of Tele. control input during stopped ON timer, operation will be started at that time and the timer will be cleared.
- In case of Tele. control input during operation of the OFF timer, the operation will be stopped at that time and the timer will be cleared.
- Even when operation stop is executed at the time of outside fan OFF by overload, automatic fresh defrosting will not be executed.
- In case of switching to "Heating" during "Automatic" heating operation, the operation will be continued as it is when the thermostat is ON. 3 min delay will not be entered. However, the set room temperature and the blowing velocity will be according to the remote control signal. The same applies for switching from "Heating" to "Automatic" heating.
- In case of switching from "Sensor dehumidification" operation to "Cooling", as it is when the thermostat is ON. 3 min delay will not be entered. However, the set room temperature and the blowing velocity will be according to the remote control signal. The same applies for switching from "Cooling" to "Sensor dehumidification". The same also applies for "Automatic" sensor dehumidification, cooling "Sensor dehumidification", "Cooling".
- The filter sign lights after operation of the indoor fan for 100 hours. The time is cleared by the filter switch.
- After entry into trouble mode (when the indication lamp is flashing), the rapid feed mode can not be changed.
- When operation by nice temperature reservation is executed during sleep operation, normal operation will be continued, and the advance time becomes the temperature difference between the set temperature without sleep shift and the room temperature.
- The 60 minutes of defrosting prohibition are counted from thermostat ON after start/stop switch ON. When the thermostat is OFF at the time of start/stop switch ON, the 60 minutes will be counted from the time of thermostat ON. The initial OFF time is not counted. Counting starts when the thermostat becomes ON, and the count then continues even if the thermostat becomes OFF.
- In case of switching from "Heating" the reversing valve is held for 3 minutes.
- The defrosting signal is not accepted with overload input, and the operation becomes as shown below when the overload input disappears.
 - When previously the defrosting signal existed without overload input, defrosting will start immediately.
 - In cases other than the above, defrosting will be executed with a defrosting signal in the condition without overload input.

Low Power Dehumidification	(2) When the set temperature is lower than the room temperature.	(2) Set temperature higher than room temperature.
	<p>Notes:</p> <ul style="list-style-type: none"> The min. ON time of the power relay is 3 minutes, and the min. OFF time is also 3 minutes. The indoor fan is not delayed in operation when the Dry button is pressed ON. 	<p>Notes:</p> <ul style="list-style-type: none"> Focused operation by Dry button ON is executed even with thermostat OFF. The room temperature 30 sec after operation start minus 0.33 deg., becomes the set temperature. When the room temperature is 16°C or lower, 16°C becomes the set temperature. The other operation are the same as for (1). The indoor fan is not delayed in operation when the Dry button is pressed ON.

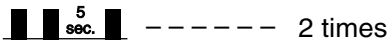
Timer-Lamp, break-down checking in blinking sign.

Check the break-down factor from the frequency of timer-lamp blinking.

No.	Mode of Timer-Lamp blinking	Indication Factor	Estimated Break-Down Part
1	 2 times	<u>Forced cool operation</u> Running force-cool operation by service switch. Service switch at indoor P.W.B. has been activated.	(1) Service switch at Indoor has been set to "COOL" position. (2) Control P.W.B. damaged.
2	 13 times	<u>IC 401 Data read wrongly</u> In case that data read from IC401 is wrong.	IC401 is not in order.
3	 14 times	<u>Heat exchanger thermistor error</u> Heat exchanger thermistor open or short-circuit detected.	(1) Thermistor (2) Indoor - control circuit board.
4	 15 times	<u>Room thermistor error</u> Room thermistor error open or short-circuit detected.	(1) Thermistor (2) Indoor - control circuit board.

( -- 0.5 second on, 0.5 second off.)

REFRIGERATION CYCLE

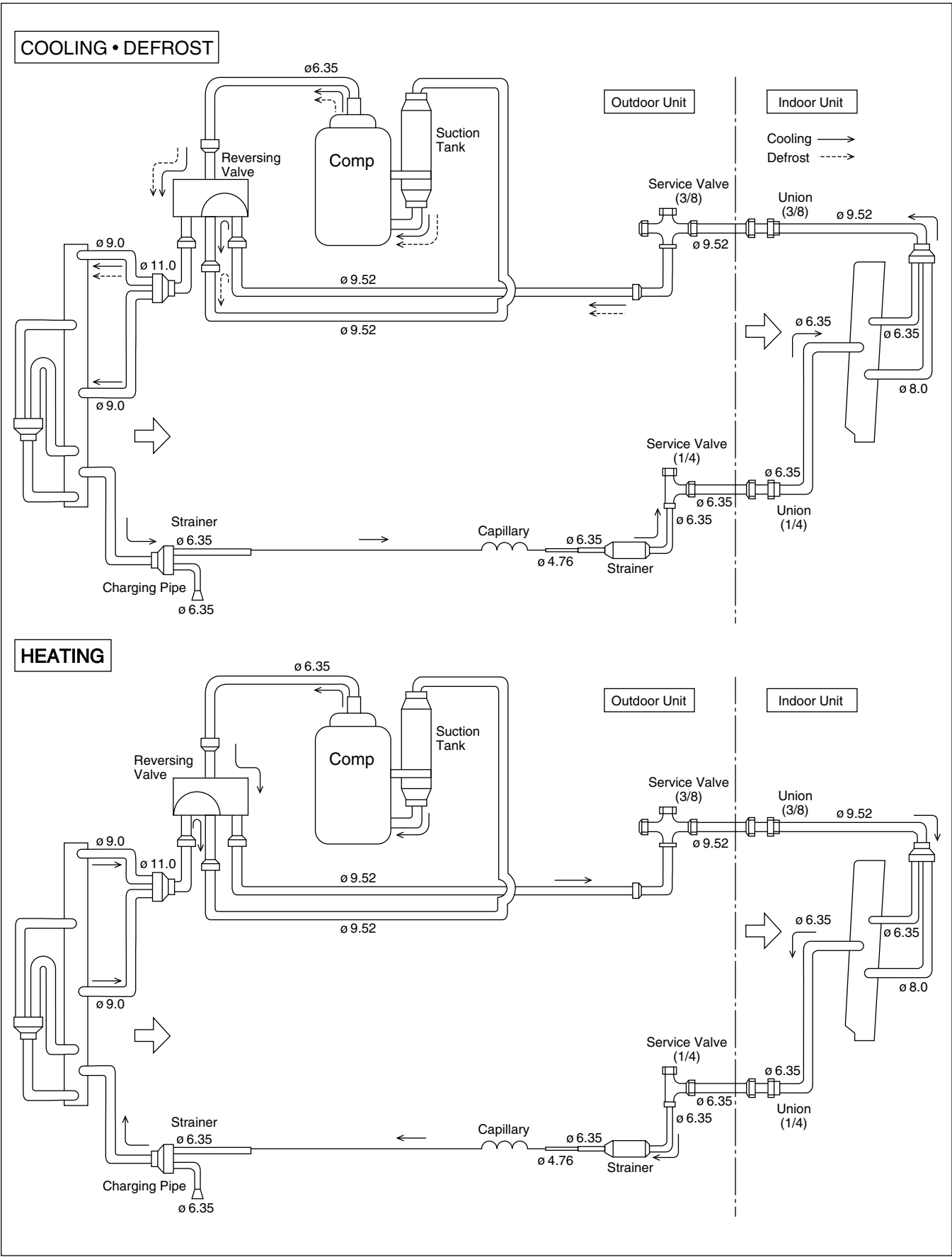

AUTO SWING FUNCTION

INPUT SIGNAL	PRESENT CONDITION		OPERATING SPECIFICATION	REFERENCE
	OPERATION	OPERATION MODE		
KEY INPUT	STOP	EACH MODE	STOP	ONE SWING (CLOSING AIR DEFLECTOR) ① DOWNWARD ② UPWARD STOP AT THE MOMENT.
	DURING OPERATION	AUTO COOL COOL FAN AUTO DRY DRY	STOP	
INTERNAL FAN ON (THERMO. ON)	DURING OPERATION	AUTO DRY DRY	DURING SWINGING	START SWINGING ① DOWNWARD ② UPWARD ③ DOWNWARD STOP AT THE MOMENT.
			TEMPORARY STOP	START SWING AGAIN.
INTERNAL FAN OFF (THERMO. OFF)			DURING SWINGING	STOP SWINGING TEMPORARILY. (SWING MODE IS CLEARED IF SWING COMMAND IS TRANSMITTED DURING TEMPORARY STOP.)
MAIN SWITCH ON	STOP	COOL FAN DRY CIRCULATOR	STOP DURING ONE SWING	INITIALIZE ① DOWNWARD ② UPWARD
			STOP DURING ONE SWING	INITIALIZE ① DOWNWARD
MAIN SWITCH OFF	DURING OPERATION	EACH MODE	STOP DURING SWINGING	ONE SWING (CLOSING AIR DEFLECTOR) ① DOWNWARD ② UPWARD
			DURING INITIALIZING	
CHANGE OF OPERATION	DURING OPERATION	EACH MODE	STOP	INITIALIZING CONDITION OF EACH MODE.
			DURING SWINGING	STOP SWINGING AND MODE BECOMES INITIALIZING CONDITION.

SERVICE CALL Q & A

Cooling operation

Q1 While cooling, the compressor sometimes stops abruptly.

A1 Check whether frost sticks on the heat exchanger of unit or not.
Wait for 3 - 4 minutes until the frost melts.

If cooling is performance when the room temperature is low, frost may stick on the heat exchanger of unit.

Dehumidifying operation

Q2 The fan speed does not change during a dehumidifying operation.

A2 The fan speed is always QUIET at a dehumidifying operation.

Q3 Cold air comes out during a dehumidifying operation.

A3 To improve the dehumidification efficiency, QUIET fan speed operation is performed. Therefore the air is cold. This is not a trouble.

Q4 The operation does not stop even by raising the room temperature setting of remote control at a dehumidifying operation.

A4 At a dehumidifying operation, the actual room temperature is compared with the room temperature setting when starting the operation and the operation is as follows.

- 1) When actual room temperature > room temperature setting
The operation is according to the room temperature setting on the remote controller.
- 2) *When actual room < room temperature setting
Regardless of the room temperature setting, the temperature is automatically set slightly lower than the room temperature.
In this case, the status in 2) is the case and, therefore, the operation by the room temperature control is impossible. Turn off the ON/OFF button, set the room temperature to a new value and turn on the operation by the ON/OFF button.

Q5 In the dehumidifying mode, the remote controller is set slightly higher than the room temperature but the operation starts.

A5 This is the status in 2) of (A4). The temperature is set a little lower than the room temperature to carry out a dehumidifying operation as far as possible.

Heating operation

Q6 Air does not come out when starting a heating operation.

A6 It is not a trouble. The fan is stopped to avoid cold wind.

When starting the operation, the heat exchanger is cold and, therefore, the fan is stopped. Wait 2–3 minutes.

Q7 Air does not come out sometimes while in a heating operation.

A7 Defrosting is on. Wait for 5–10 minutes until the outdoor unit is defrosted.

Q8 The fan speed is set to “HI” or “MED” but the heating operation starts with a LO fan speed.

A8 The heating operation starts with a LO fan speed for 30 seconds. If the fan speed is set to HI, the operation starts with LO fan speed, followed by MED fan speed for 30 seconds and then by HI fan speed.

Q9 The operation stops during a heating operation while the room temperature is set at “30”.

A9 If a heating operation is performed when the exterior temperature is high, the operation may stop to protect the equipment.

Q10 The outdoor fan does not move at a heating operation by the service switch.

A10 It is not a trouble. When heating, the outdoor fan is stopped to avoid excessive pressure rise.

Auto fresh defrosting

Q11 Heating has been turned off by the main operation but the “Hot keep lamp” lights and the outdoor unit operations.

A11 “Auto fresh defrosting” operates. When stopping the operation, whether the outdoor unit is frosted or not is checked and, if in the affirmative, defrosting is performed before stopping the operation.

Automatic operation

Q12 How is the automatic operation mode determined?

A12 According to the room temperature, cooling, heating or dehumidifying operation automatically selected.

Cooling:
When room temperature is approx. 27°C or higher.

Dehumidifying:
When room temperature is between approx. 23°C and 27°C.

Heating:
When room temperature is approx. 23°C or lower.

Q13 At an automatic operation, changing the fan speed change switch does not vary the fan speed.

A13 The fan speed is automatically determined.

Q14 The room temperature cannot be controlled at an automatic operation.

A14 It is automatically set as follows.

At cooling: Set at 27°C

At dehumidifying:
Set slightly lower than room temperature

The room temperature setting can be raised 3°C by “Λ” or lowered 3°C by “V”.

When changing the room temperature setting in an automatic operation, the next automatic operation mode is determined by new room temperature setting. If, for example, the room temperature setting is 2°C lowered for example, the operation mode is as follows.

Cooling: When room temperature is approx. 27°C or higher.

Dehumidifying:
When room temperature is between approx. 23°C and 27°C.

Heating: When room temperature is approx. 23°C or lower.

Common, etc.

Q15 There is a difference between the room temperature setting and actual room temperature.

A15 There may be a difference between the room temperature setting and actual room temperature on account of the room structure, air flow, etc. If there is a difference, adjust the set temperature to keep living space at a comfortable temperature.

Q16 What will happen if the time setting is changed while in a timer operation?

A16 A timer operation is performed until the time after changing the time setting.

Wireless remote controller

Q17 1) When the “Automatic” operation mode is selected, “Automatic” does not change by pressing the fan speed select button.

2) The room temperature setting is not displayed.

3) Pressing the room temperature control button develops a transmit mark “” and sounds a receive sound but does not display the room temperature setting.

A17 1) When the operation mode is “Automatic”, the fan speed is automatically fixed to “Automatic”.



2) At an “Automatic” operation, the room temperature setting is not displayed. The room temperature is automatically set as follows.

At cooling
Set at 27°C.

At dehumidifying
Set to a temperature slightly lower than the room temperature.

At heating
Set at 23°C.

3) At an “Automatic” operation, the room temperature setting is not displayed.

However, every pressing “” or “” button changes 1°C within the range of:
27±3°C when cooling
23±3°C when heating

The room temperature sensing thermistor in the indoor unit detects the room temperature and, according to the particular temperature, automatically performs “Cooling” or “Dehumidifying” operation. The value indicated not at an “Automatic” but manual operation is not the actual room temperature but the room temperature setting.

Wireless remote controller

Q18 When the room temperature setting is “16”, pressing the room temperature control button “V” causes no transmission. At “32”, pressing “Λ” causes no transmission either.

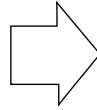

A18 The room temperature is settable within the range of 16 - 32 and not beyond.

Q19 In spite of timer “Preprogram”, setting is extinguished.

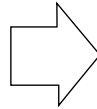

A19 Isn't the time over the preprogrammed time?
As soon as the preprogrammed time is reached, the time setting disappears.

When setting the current time, its indication blinks for approximately 3 minutes.

Q20 After selecting a “Dehumidifying” operation mode, the fan speed mode remains “LO” fan speed.

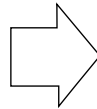

A20 At a “Dehumidifying” operation, the “LO” fan speed is forcibly selected.

PARTS LIST AND DIAGRAM

MODEL RAS-07CH4, RAS-09CH4

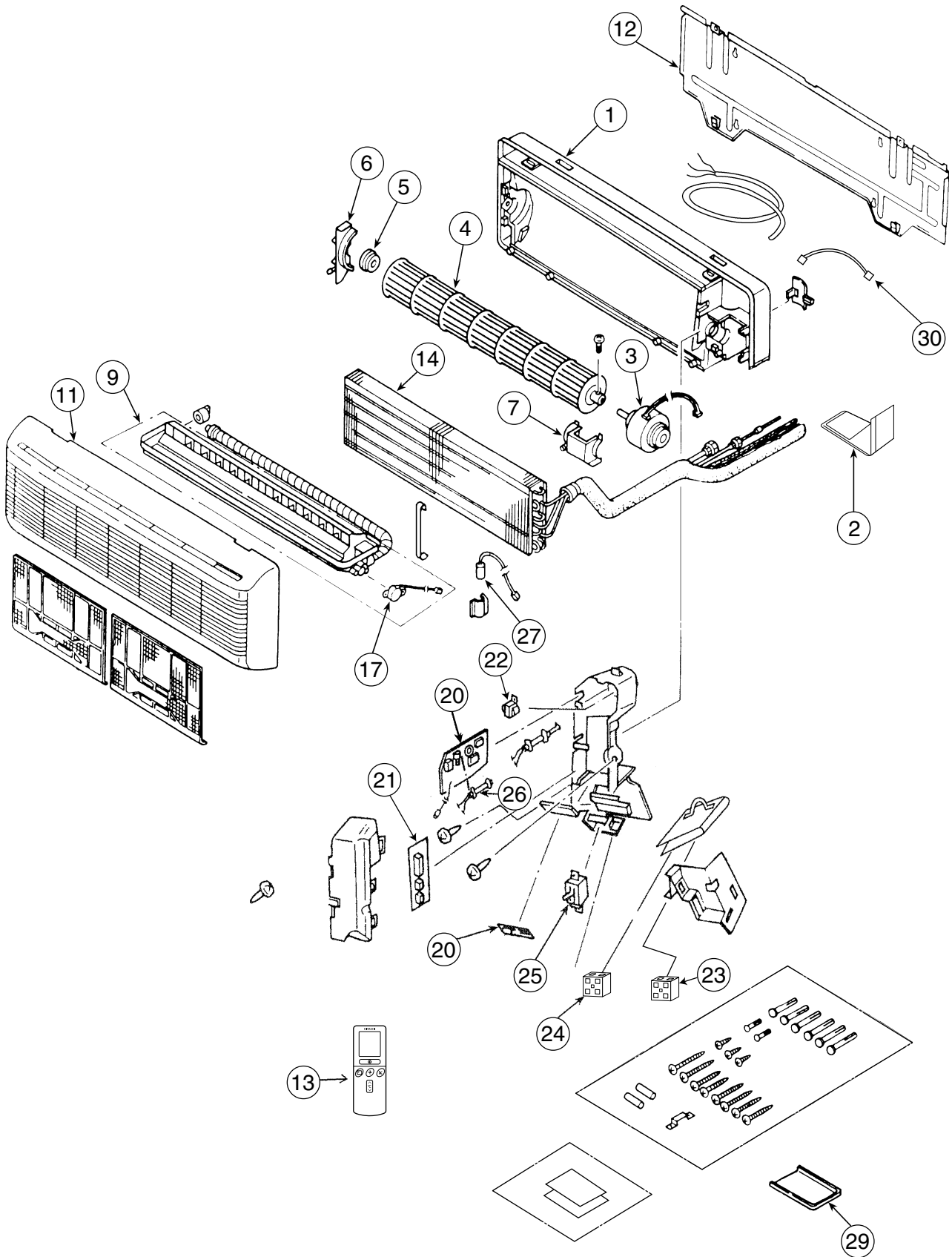

MODEL RAC-07CH4, RAC-09CH4

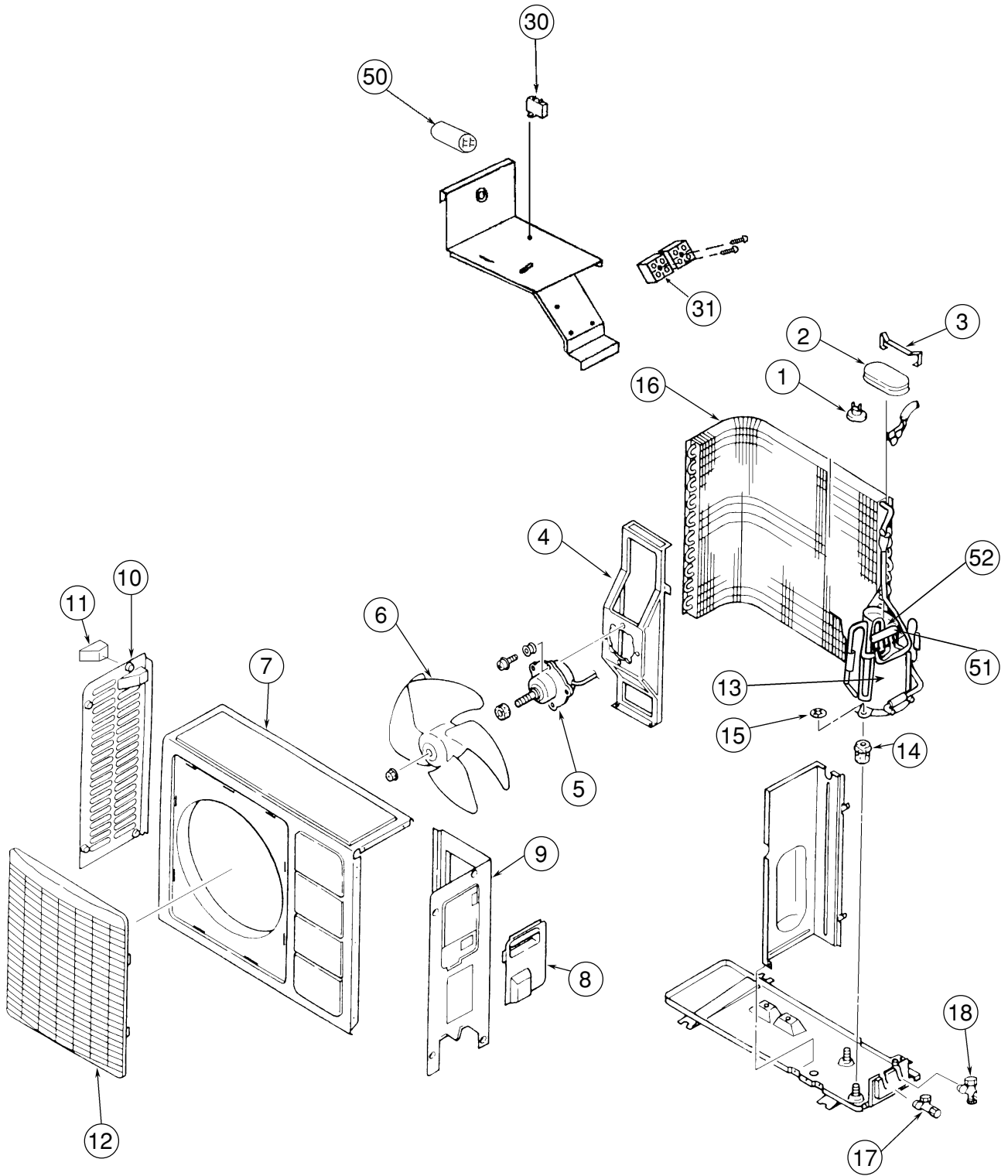

HITACHI